



US007209173B2

(12) **United States Patent**  
**Fossum**

(10) **Patent No.:** **US 7,209,173 B2**  
(45) **Date of Patent:** **\*Apr. 24, 2007**

(54) **METHODS OF OPERATING  
PHOTODIODE-TYPE PIXEL AND IMAGER  
DEVICE**

(75) Inventor: **Eric R. Fossum**, La Crescenta, CA  
(US)

(73) Assignee: **Micron Technology, Inc.**, Boise, ID  
(US)

(\* ) Notice: Subject to any disclaimer, the term of this  
patent is extended or adjusted under 35  
U.S.C. 154(b) by 0 days.

This patent is subject to a terminal dis-  
claimer.

(21) Appl. No.: **11/450,362**

(22) Filed: **Jun. 12, 2006**

(65) **Prior Publication Data**

US 2006/0227233 A1 Oct. 12, 2006

**Related U.S. Application Data**

(63) Continuation of application No. 10/273,085, filed on  
Oct. 16, 2002, which is a continuation of application  
No. 09/025,079, filed on Feb. 17, 1998, now Pat. No.  
6,667,768.

(51) **Int. Cl.**  
**H04N 3/14** (2006.01)  
**H04N 5/335** (2006.01)

(52) **U.S. Cl.** ..... **348/308**; 348/313

(58) **Field of Classification Search** ..... 348/308,  
348/309, 301, 302, 303, 313, 314, 362, 296,  
348/297; 257/292, 291, 237, 239, 216; 250/208.1  
See application file for complete search history.

(56) **References Cited**

**U.S. PATENT DOCUMENTS**

4,369,378 A 1/1983 Rockett, Jr.

4,644,572 A	2/1987	Lambeth
4,684,800 A	8/1987	Morse et al.
4,686,648 A	8/1987	Fossum
4,744,623 A	5/1988	Prucnal et al.
4,776,925 A	10/1988	Fossum et al.
4,839,735 A	6/1989	Kyomasu et al.
4,920,069 A	4/1990	Fossum et al.
5,054,040 A	10/1991	Yariv et al.
5,055,900 A	10/1991	Fossum et al.
5,080,214 A	1/1992	Fossum
5,105,277 A	4/1992	Hayes et al.
5,236,871 A	8/1993	Fossum et al.
5,343,297 A	8/1994	Tiemann et al.
5,386,128 A	1/1995	Fossum et al.
5,471,515 A	11/1995	Fossum et al.
5,548,773 A	8/1996	Kemeny et al.
5,665,959 A	9/1997	Fossum et al.
5,793,322 A	8/1998	Fossum et al.
5,841,126 A	11/1998	Fossum et al.
5,872,371 A	2/1999	Guidash et al.
5,880,691 A	3/1999	Fossum et al.

(Continued)

*Primary Examiner*—Aung Moe

(74) *Attorney, Agent, or Firm*—Dickstein Shapiro LLP

(57) **ABSTRACT**

Operation for global electronic shutter photodiode-type pixels. In a first mode of operation, lag is reduced through global reset of the photodiode array and fixed pattern noise is eliminated through comparison of the photosignal level and the reset level of the floating drain. In a second mode of operation, simultaneous integration and readout processes are achieved through cessation of spill charges over the transfer gate. In a third mode of operation, regulation of the reset photodiode and transfer gate enables voltage gain between the photodiode and the sense node.

**11 Claims, 8 Drawing Sheets**

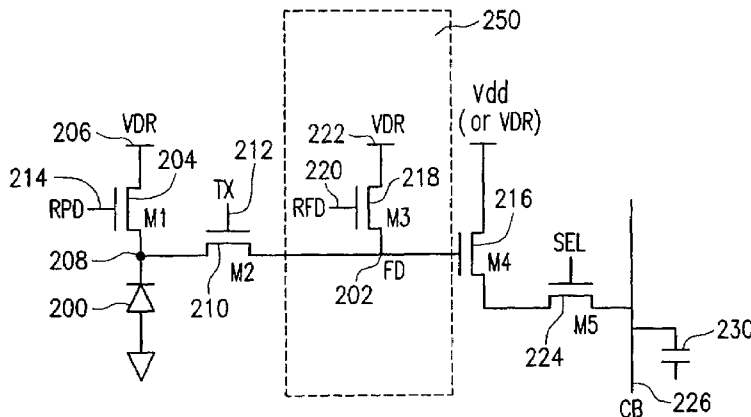

# US 7,209,173 B2

Page 2

---

U.S. PATENT DOCUMENTS			
5,886,659	A	3/1999	Pain et al.
5,887,049	A	3/1999	Fossum
5,909,026	A	6/1999	Zhou et al.
5,920,345	A	7/1999	Sauer
5,949,483	A	9/1999	Fossum et al.
5,952,645	A	9/1999	Wang et al.
5,962,844	A *	10/1999	Merrill et al. .... 250/208.1
5,990,506	A	11/1999	Fossum et al.
5,995,163	A	11/1999	Fossum
6,005,619	A	12/1999	Fossum
6,008,486	A	12/1999	Stam et al.
6,021,172	A	2/2000	Fossum et al.
6,057,539	A	5/2000	Zhou et al.
6,137,100	A	10/2000	Fossum et al.
6,166,768	A	12/2000	Fossum et al.
6,201,270	B1	3/2001	Chen
6,667,768	B1 *	12/2003	Fossum ..... 348/308
2003/0103153	A1 *	6/2003	Fossum ..... 348/308

\* cited by examiner

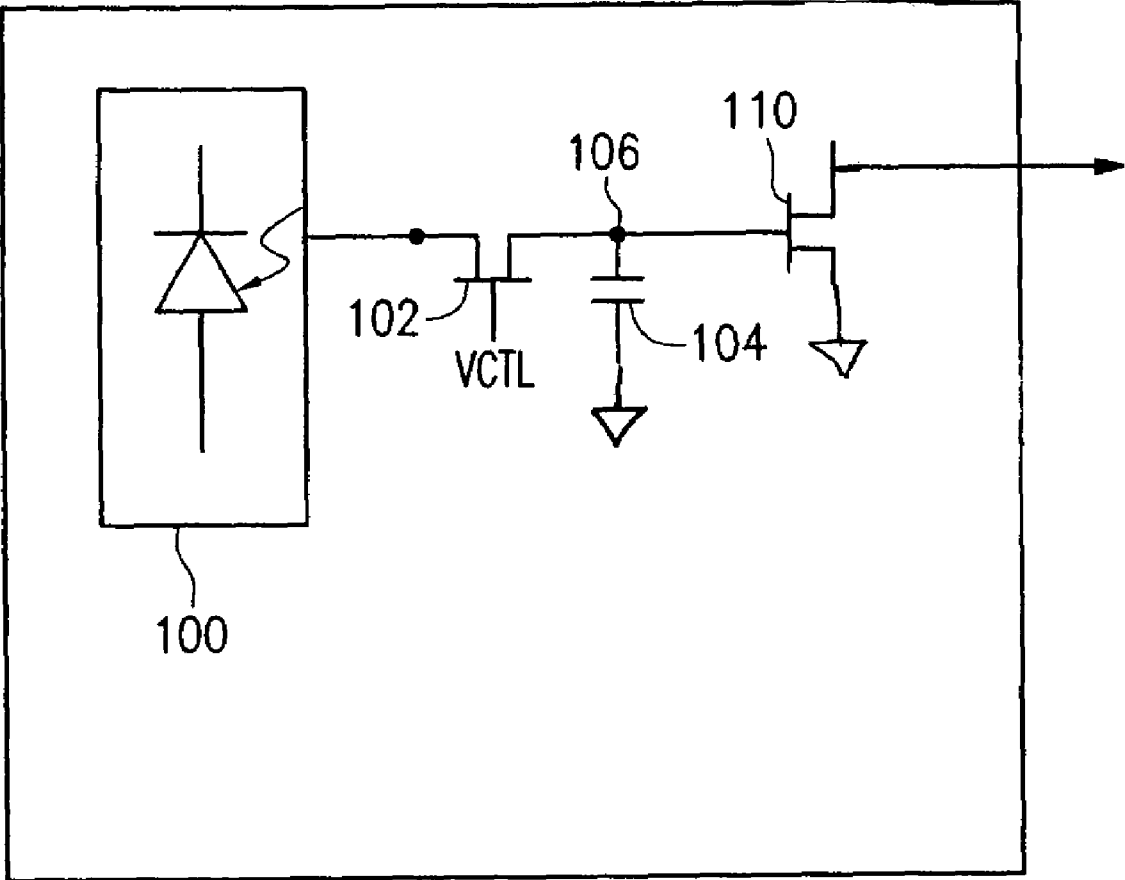

FIG. 1

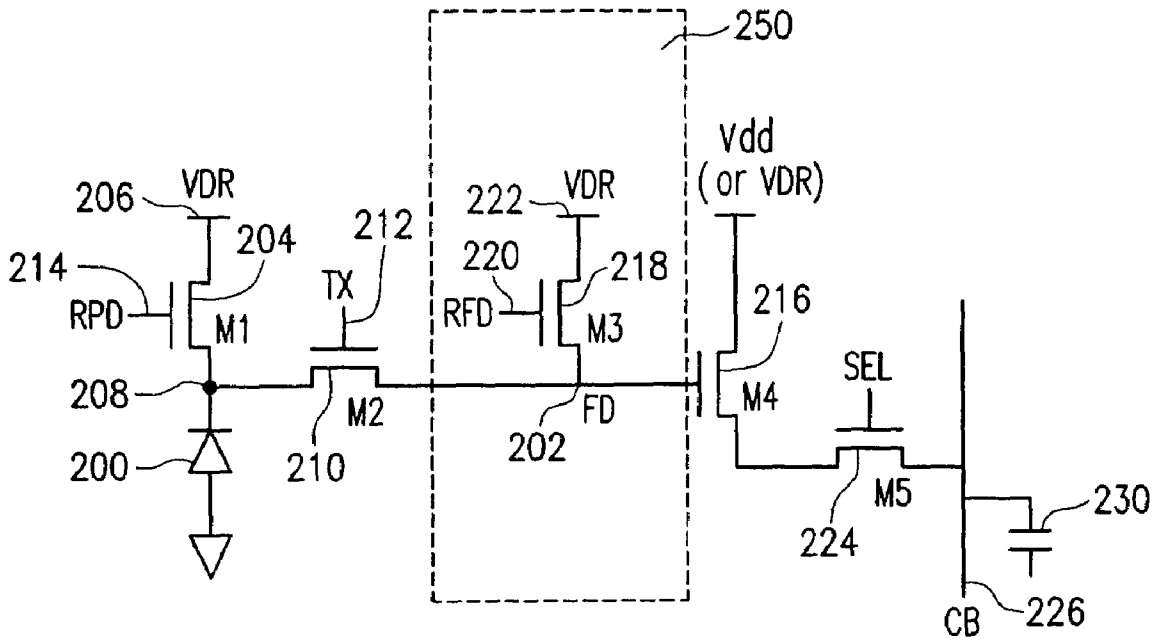

FIG. 2A

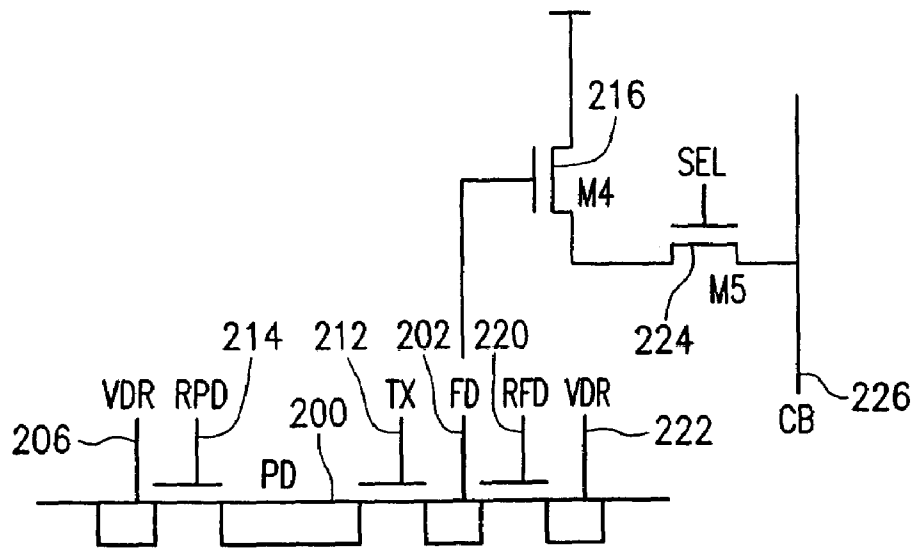

FIG. 2B

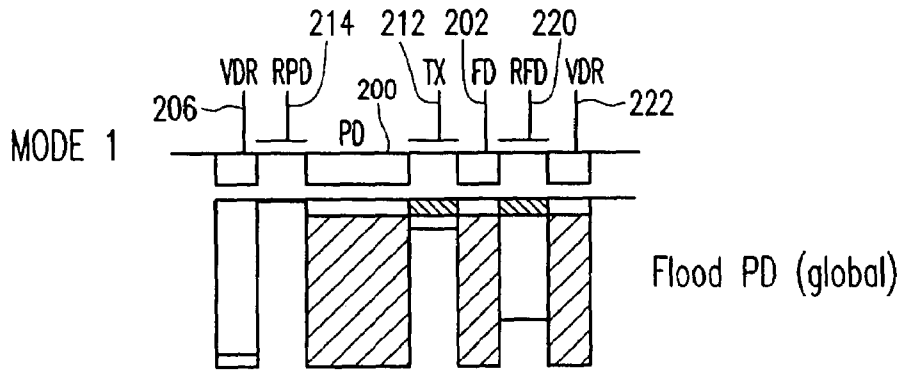

FIG. 3A

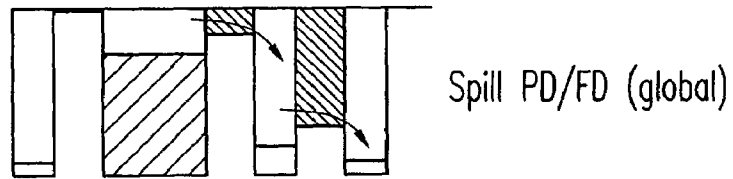

FIG. 3B

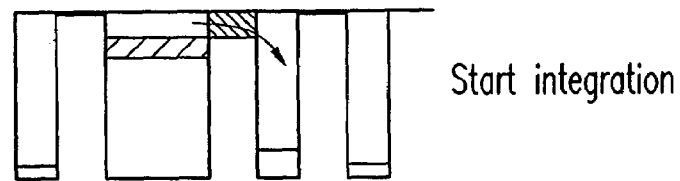

FIG. 3C

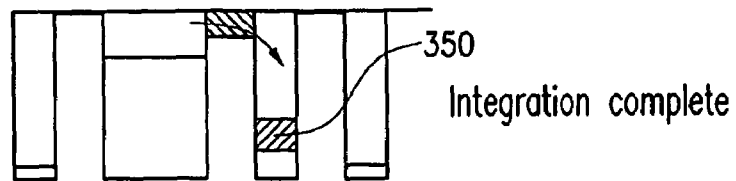
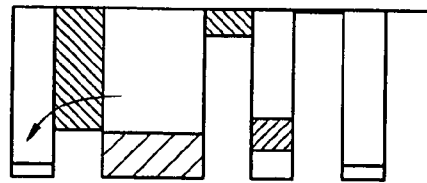
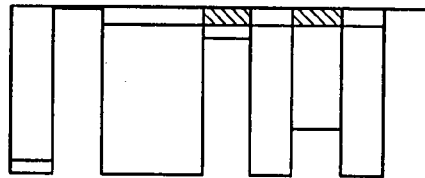

FIG. 3D



Shutter closed  
Start reading rows  
Read row n FD

**FIG. 3E**



Flood PD (row n)

**FIG. 3F**

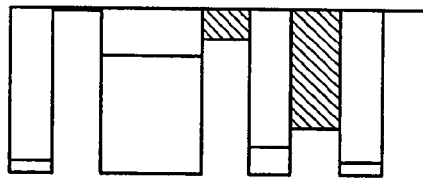

Spill PD/FD (row n)

**FIG. 3G**

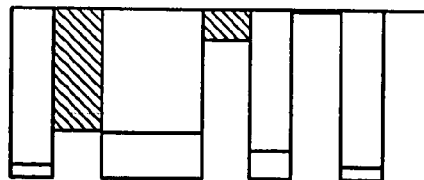

Move on to row n+1

**FIG. 3H**

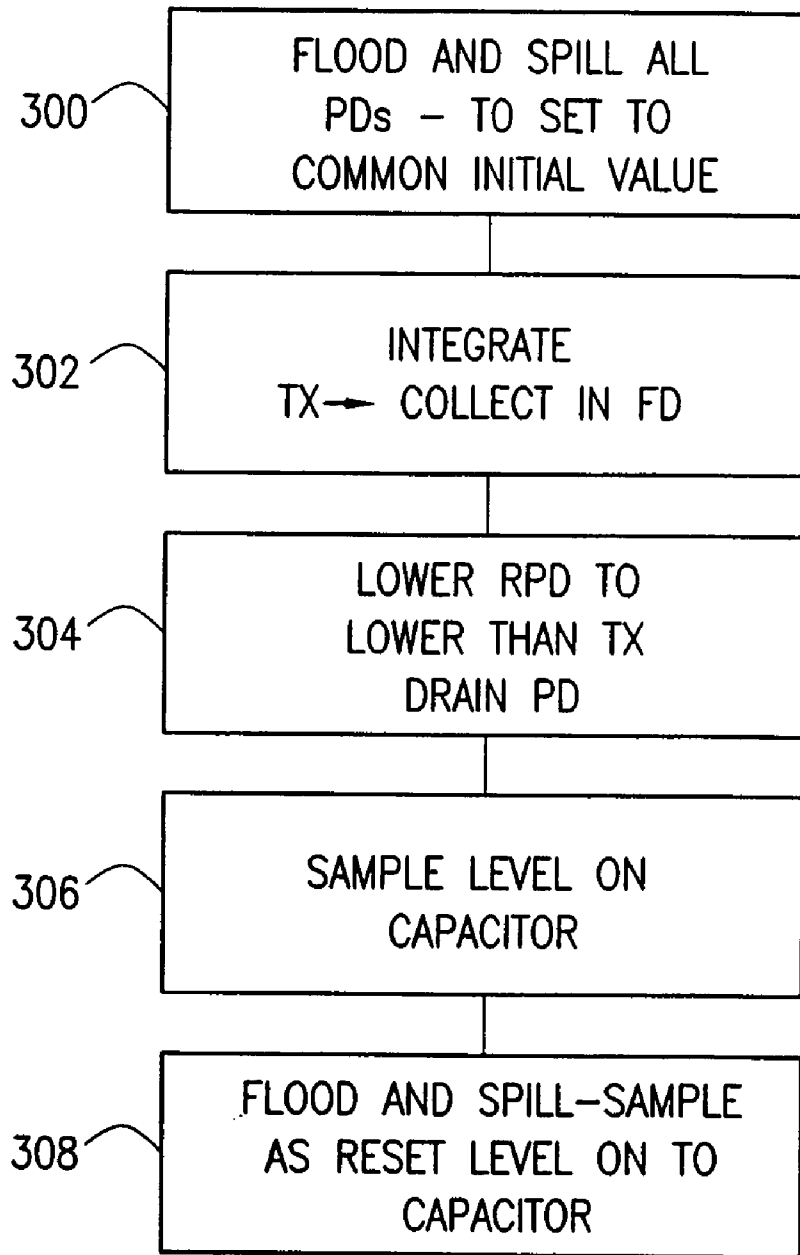

**FIG. 3I**

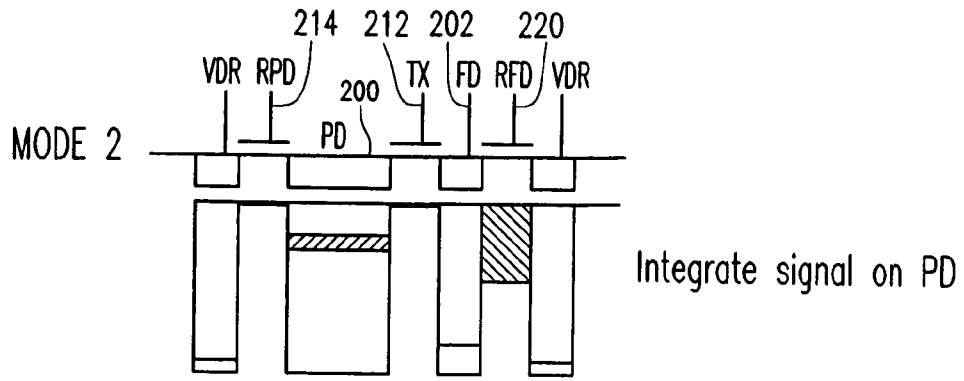

FIG. 4A

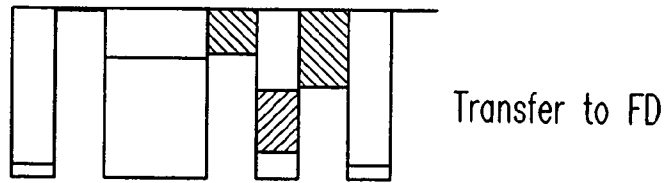

FIG. 4B

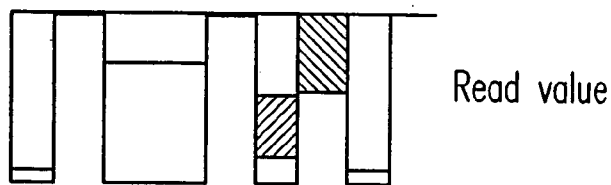

FIG. 4C

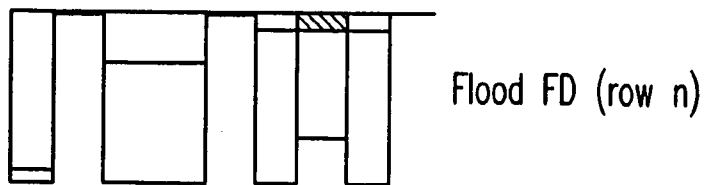
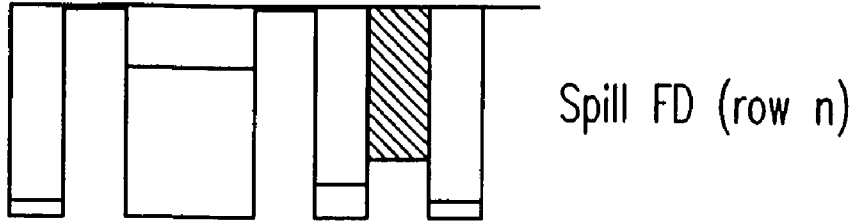
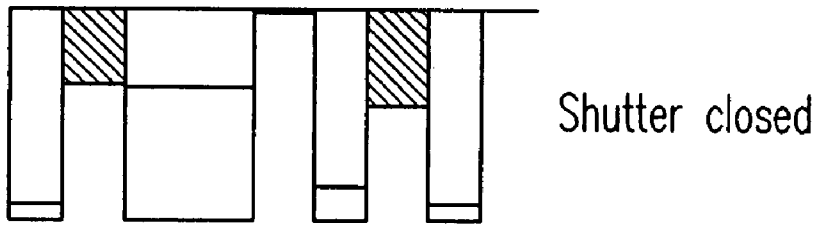

FIG. 4D

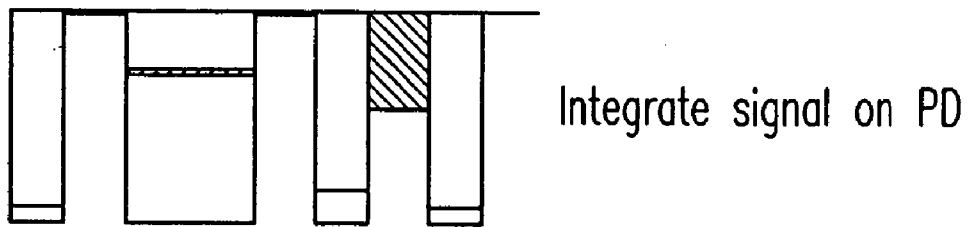



**FIG. 4E**



**FIG. 4F**



**FIG. 4G**

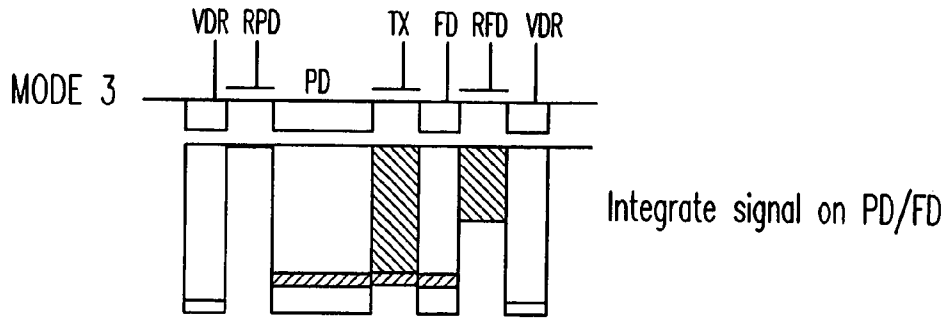

FIG. 5A

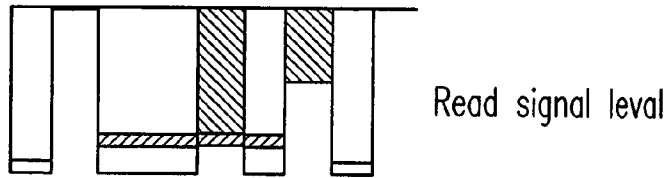

FIG. 5B

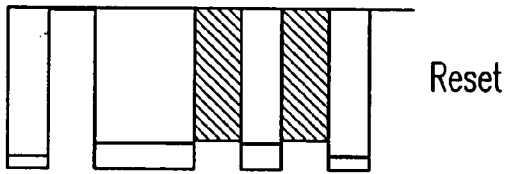

FIG. 5C

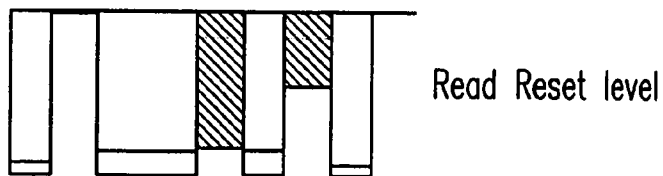

FIG. 5D

## METHODS OF OPERATING PHOTODIODE-TYPE PIXEL AND IMAGER DEVICE

### CROSS-REFERENCE TO RELATED APPLICATIONS

The present application is a continuation of and claims priority to U.S. application Ser. No. 10/273,085, filed Oct. 16, 2002, which is a continuation of U.S. application Ser. No. 09/025,079, filed Feb. 17, 1998 (now U.S. Pat. No. 6,667,768), the entire disclosures of which are incorporated herein by reference.

### TECHNICAL FIELD

This disclosure relates to active image capturing using photodiodes. More particularly, the present disclosure describes to active pixel devices using photodiodes as their active elements.

### BACKGROUND

Active pixel devices include a light sensing element, and internal image processing structure. Many active pixel sensors, such as that described in U.S. Pat. No. 5,471,515, the disclosure of which is incorporated by reference herein, have a buffer structure, e.g., a source follower, as part of each pixel.

Active pixel sensors can use photodiodes or photogates, or other light sensitive elements. In many photodiode type active pixels, the light sensitive element is directly connected to the active pixel amplifier and/or buffer.

A global shutter effect commands all the pixels to integrate for the same short absolute period of time. This effectively freezes the motion of objects. However, in a photodiode device, an external light blocking shutter has typically been used to stop the photodiode from accumulating photosignal.

FIG. 1 shows one approach. A sampling switch **102** and capacitor **104** are used. Sampling switch **102** is placed between the photodiode **100** and the capacitor **104**. The capacitor charge node **106** is connected to the active pixel amplifier **110**. The photodiode voltage is sampled by a closing switch **102** and allowing the charge from the photodiode to charge sampling capacitor **104**. Switch **102** and capacitor **104** are covered by a metallic light shield to avoid pickup of undesirable light signal. This allows freezing the charge output at any given time.

However, the charge from the photodiode **100** is shared onto the capacitor **104** in the voltage domain. When the switch **102** is closed, the charge flows from the photodiode **102** in order to equalize the voltage between photodiode output and capacitor **106** node. Thus, the maximum signal-induced voltage swing of the capacitor **104** may be limited by the voltage of the photodiode. Since charge is shared, the voltage swing is in fact, always lower. Furthermore, turning off the sampling switch may itself inject charge to the sampling capacitor. This, in turn, adds offset and noise.

### SUMMARY

The present disclosure describes an approach to this drawback described above. This is done by enabling voltage gain between the photodiode **100** and its sensing node.

The embodiment reduces lag in a photodiode-type active pixel for a global electronic shutter. More particularly, the

invention operates in three modes to achieve improved image quality and photodiode performance.

In the first mode of operation, an image is captured by a photodiode array. Lag is reduced when the photodiodes are globally reset by a flood and spill of charge cycle. A readout phase follows the reset phase. During this second phase, image quality is improved by the elimination of fixed pattern noise through the comparison of the photosignal level and the reset level of the floating drain.

In the second mode of operation, global shutter simultaneous integration and readout processes are achieved by cessation of charges which trickle out over the transfer gate as in the first mode.

In the third mode of operation, lower conversion gain of a combined photodiode is achieved by restoring the sensor to normal operation through regulation of the reset photodiode and the transfer gate.

The details of one or more embodiments of the invention are set forth in the accompanying drawings and the description below. Once the details of the invention are known, numerous additional innovations and changes will become obvious to one skilled in the art.

### DESCRIPTION OF DRAWINGS

FIG. 1 is a diagram of an embodiment of a photodiode type active pixel.

FIG. 2A is a diagram of a photodiode-type active pixel in accordance with the invention.

FIG. 2B is a detailed diagram of the photodiode-type active pixel in accordance with the invention.

FIGS. 3A–3I are diagrams of a photosignal integration and readout phase operation in accordance with the invention.

FIG. 4A–4G are diagrams of a photosignal integration and readout phase operation for simultaneous integration and readout processes in accordance with the invention.

FIG. 5A–D is a diagram of a photosignal integration and readout phase operation for a combined photodiode with lower conversion gain in accordance with the invention.

Like reference numbers and designations in the various drawings indicate like elements.

### DETAILED DESCRIPTION

An embodiment is shown in FIGS. 2A and 2B. This embodiment minimizes the problem of charge injection, and also reduces lag.

FIG. 2A shows a schematic view of the preferred circuit. Photodiode **200** is connected to the source of FET **204** whose drain is connected to a bias voltage level VDR **206**. FET **204** is used to reset the photodiode. Signal RPD **214** controls reset of the photodiode.

FET **210** also connects the photodiode output node **208** to a floating diffusion (“FD”) node **202**. FD has a capacitance of approximately 0.016 pf (or 10  $\mu\text{V}/e^-$ ). FET **210** is driven by a signal applied to transfer gate TX **212**. Preferably, the FET is dc-biased in a 5 volt n-well implementation at about 1 volt.

FD **202** is connected to the gate of source-follower FET **216** which acts as a buffer and amplifier. The output is gated by selector transistor **224**, and selectively driven to column bus **226**.

The voltage on FD **202** is also reset under control of FET **218**. FET **218** is driven by reset floating diffusion control voltage RFD **220**. The reset transistor **218** resets the node to the level of voltage VDR **222**.

FIG. 2B shows the same circuit in transistor well form. While FIG. 2A shows these devices as transistors, FIG. 2B shows them more accurately as gates and wells.

The operation of the image sensor in a first mode of operation is explained with reference to FIGS. 3A–3H, and the flowchart of FIG. 3I. This sensor operates in two phases—an image acquisition phase, and an image readout phase. This preferred mode of the sensor separates read out from integration in order to allow a simultaneously integrating electronic shutter and the dual sampling for fixed pattern noise reduction.

The inventors recognized that lag is caused by an initial value in the photodiode at a beginning of integration. This embodiment starts with a global reset of the photodiodes at 300 and in the state shown in FIG. 3A. All photodiodes in the entire array are operated simultaneously. Voltage drain VDR 222 is initially set to 5 volts and RPD 214 is off. RFD 220 is turned on and VDR 206 is set to ground. This floods photodiode 200 and FD 202 with charge, as shown in FIG. 3A.

After approximately 1  $\mu$ s, VDR 222 is returned to 5 volts as shown in FIG. 3B. This causes the flooded PD 200 to spill out over transfer gate TX 212 to the level set by the bias on 212. It also causes the charge on FD to spill over transistor 218's RFD barrier to VDR 222. This spill cycle also lasts approximately 1  $\mu$ s.

The flood and spill ensures that the initial conditions on PD 200 will be the same for all frames and that its initial state is erased. Since all initial conditions are the same, artifacts, and hence lag, is eliminated or reduced.

After the reset, PD 200 integrate the photosignal for the desired integration period, as step 302 in FIG. 3I, and as shown in FIG. 3C. The initial flood and spill has left the PD charged to the level of the TX barrier. Hence, as the photosignal is collected, it trickles over TX 212 barrier and is collected by FD 202 as collected charge 350.

The change in voltage on node FD 202 is determined by its capacitance and is estimated above to be  $10 \mu\text{V}/e^-$ .

The integration period is ended by setting RPD 214 to 5 volts, as shown in FIG. 3E. This effectively closes the shutter by draining all additional photoelectrons from PD down to the level of the RPD, over the transistor 210 barrier to the drain level CDR 206. The barrier RPD is kept lower than TX 212 to ensure that the photoelectrons are drained away and not into the FD, as shown in step 304. Hence, the photosignal is held on FD 202. FD 202 is covered by a light shield 250 and protected from unwanted light signal. The output of the floating diffusion drives the high impedance input of a source follower transistor 216. The signal is hence stored as long as RPD 214 remains on. This continues until after the pixel is selected for readout.

In the readout phase, pixels are selected a row at a time by the select transistor 224. When enabled, the voltage on the output of the source follower transistor 216 is driven onto the column output bus CB 226. When the row is first selected, the voltage is sampled onto capacitor 230 at 306. This represents the photosignal level (VS). Photodiode 200 and output node FD 202 is then reset by another flood and spill sequence as above, and shown in 3F and 3G. The cycle is timed identically to the global reset described above. At the completion of the cycle, RFD 220 is set low and FD 202 is sampled. This represents the reset level (VR) of the floating drain FDR. That voltage is sampled on to capacitor 230 to form a difference between VS and VR which is proportional to the integrated light signal during the integration period. By taking the difference, fixed pattern noise introduced by transistor threshold non-uniformities and pos-

sibly timing skew across rows is minimized, thereby improving image quality. After subsequent processing (e.g., analog and digital conversion and readout), the next row is selected for readout, as shown in FIG. 3H.

This process repeats until all rows desired for readout have been read out. The sensor then returns to its integrate mode.

Because charge is transferred in a trickle mode between the PD 200 and FD 202, operations affecting either node during integration and prior to readout may adversely affect the accuracy.

An alternative mode 2 is illustrated in FIGS. 4A–4E. In mode 2, charge is not continuously trickled over the TX 212 barrier. After the flood and spill cycle of FIGS. 3A and 3B, TX 212 is set low (to ground) as shown in FIG. 4A. This causes the photodiode to integrate the incoming charge. Charge can then be transferred to FD 202 all at once, at a desired time. TX 212 is returned to its initial spill value. This transfers the excess charge obtained since the spill of FIG. 3b from PD 200 to FD 202. FD 202 can then be read out as shown in FIG. 4C. The reset level of FD is estimated by performing the flood and spill operation with TX 212 set low, as shown, respectively, in FIGS. 4D and 4E. This allows simultaneous integration and readout processes.

FIGS. 4F and 4G show how the shutter can be closed by enabling RPD to allow incoming charge to spill over the barrier.

This mode does not describe PD 200 being flooded between frames. RPD 214 can still be used to control the integration duty cycle, with transfer to FD 202 only during the inter-frame blanking interval. However, since the threshold voltages of RPD 214 and RFD 220 may not be equal, some offset nonuniformity can be expected. If RPD 214 is a little deeper than RFD 220 for the same applied gate voltage, PD 200 will have a “pocket” that will result in reduced signal for low light levels.

Operation of the image sensor in mode 3 is illustrated in FIG. 5. This is a diagram of a photosignal integration and readout phase for a combined photodiode with lower conversion gain in accordance with the invention.

The sensor can be restored to “normal” photodiode APS operation by keeping RPD 214 off. TX 212 is biased at V<sub>dd</sub>. This creates a combined photodiode of PD 200 and FD 202. FIG. 5A shows integrating the incoming signal on the combined PD/FD. The signal is read by sampling the source follower 216 in FIG. 5B. The PD/FD combination is then reset in FIG. 5C by turning on RFD and hence draining the PD/FD combination. At FIG. 5D, that reset level is read for correction of the reset level.

Other embodiments are contemplated. For example, different switching elements could be used. Different channel conductivities allows the biasing to be done differently. All such modifications are intended to be encompassed within the following claims.

The invention claimed is:

1. A method of operating an imager device:

performing a first reset operation on a plurality of pixels, wherein the first reset operation charges photo diodes of the plurality of pixels to an initial level substantially equal to a gate voltage of a corresponding transfer transistor coupling the photo diodes to floating diffusion regions;  
collecting photoelectrons with the photo diodes, wherein a portion of the photoelectrons exceeding the initial level is coupled through the transfer transistor to a corresponding floating diffusion region of the plurality of pixels;

5

sampling a first voltage level of the floating diffusion region to determine a photosignal;

performing a second reset operation on the plurality of pixels, wherein the second reset operation charges the photo diodes to the initial level; and

following the second reset operation, sampling a second voltage level of the floating diffusion region to determine a reset level, wherein a voltage difference between a signal level of the photosignal and the reset level represents the photoelectrons collected by the photo diode.

2. The method of claim 1, wherein the acts of performing a first reset operation and collecting photoelectrons with the photo diodes are performed simultaneously for every pixel in said imager device.

3. A method of operating an imager device comprising a photo diode and a floating diffusion region coupled through a transfer transistor, the photo diode is coupled to a bias transistor and the floating diffusion region is coupled to a reset transistor, the method comprising:

performing a first reset operation of the photo diode and floating diffusion region, the first reset operation comprises:

activating the reset transistor to bias the floating diffusion region to a positive voltage level coupled to the reset transistor, and applying a gate bias voltage to the transfer transistor to couple the photo diode to the floating diffusion region such that the photo diode is biased to the positive voltage level, and

changing a voltage coupled to the reset transistor to drain at least some charge from the photo diode and floating diffusion region, wherein the photo diode remains charged to an initial level substantially equal to the gate bias voltage applied to the transfer transistor;

following the first reset operation, turning off the reset transistor and collecting photoelectrons with the photo diode, wherein a portion of the photoelectrons exceeding the initial level is coupled through the transfer transistor to the floating diffusion region;

activating the bias transistor to terminate collection of photoelectrons with the photo diode;

sampling a first voltage level of the floating diffusion region to determine a photosignal;

performing a second reset operation on the plurality of pixels, wherein the second reset operation comprises:

activating the reset transistor to bias the floating diffusion region to the positive voltage level coupled to the reset transistor, and applying the gate bias voltage to the transfer transistor to couple the photo diode to the floating diffusion region such that the photo diode is biased to the positive voltage level, and

changing a voltage coupled to the reset transistor to drain at least some charge from the photo diode and floating diffusion region, wherein the photo diode remains charged to the initial level substantially equal to the gate bias voltage applied to the transfer transistor; and

following the second reset operation, sampling a second voltage level of the floating diffusion region to determine a reset level, wherein a voltage difference between a signal level of the photosignal and the reset level represents the photoelectrons collected by the photo diode.

6

4. A method of operating an imager device:

performing a first reset operation on a plurality of pixels, wherein the first reset operation charges photo diodes of the plurality of pixels to an initial level substantially equal to a reset gate voltage of a corresponding transfer gate coupling the photo diodes and floating diffusion regions;

lowering a voltage of the transfer gate from the reset gate voltage to an integration gate voltage;

collecting photoelectrons with the photo diodes while the integration gate voltage is applied to the transfer gate;

raising the voltage of the transfer gate from the integration gate voltage to the reset gate voltage to couple a portion of the photoelectrons exceeding the initial level through the transfer gate to a corresponding floating diffusion region of the plurality of pixels;

sampling a voltage level of the floating diffusion region to determine a photo signal;

performing a second reset operation on the diffusion regions; and

following the second reset operation, sampling a second voltage level of the floating diffusion region to determine a reset level, wherein a voltage difference between a signal level of the photosignal and the reset level represents the photoelectrons collected by the photo diode.

5. The method of claim 4, wherein the acts of performing a first reset operation and collecting photoelectrons with the photo diodes are performed simultaneously for every pixel in said imager device.

6. A method of operating an imager device comprising a photo diode and a floating diffusion region coupled through a transfer transistor, the floating diffusion region is coupled to a reset transistor, the method comprising:

performing a first reset operation of the photo diode and floating diffusion region, the first reset operation comprises:

activating the reset transistor to bias the floating diffusion region to a positive voltage level coupled to the reset transistor, and applying a reset gate bias voltage to the transfer transistor to couple the photo diode to the floating diffusion region such that the photo diode is biased to the positive voltage level, and

changing a voltage coupled to the reset transistor to drain at least some charge from the photo diode and floating diffusion region, wherein the photo diode remains charged to an initial level substantially equal to the gate bias voltage applied to the transfer transistor;

following the first reset operation, turning off the reset transistor and the transfer transistor;

collecting photoelectrons with the photo diode;

applying the reset gate bias voltage to the transfer transistor to couple a portion of the photoelectrons exceeding the initial level through the transfer transistor to the floating diffusion region;

sampling a voltage level of the floating diffusion region to determine a photosignal;

performing a second reset operation on the diffusion regions; and

following the second reset operation, sampling a second voltage level of the floating diffusion region to determine a reset level, wherein a voltage difference between a signal level of the photosignal and the reset level represents the photoelectrons collected by the photo diode.

7

7. A method of operating an imager device:  
 collecting photoelectrons with the photo diodes and float-  
 ing diffusion regions of a plurality of pixels;  
 sampling a first voltage level of the floating diffusion  
 region to determine a photo signal;  
 performing a reset operation on the plurality of pixels,  
 wherein the reset operation discharges the photo diodes  
 and floating diffusion regions to a reset level; and  
 following the reset operation, sampling a second voltage  
 level of the floating diffusion region to determine a  
 reset level, wherein a voltage difference between a  
 signal level of the photosignal and the reset level  
 represents the photoelectrons collected by the photo  
 diode.

8. The method of claim 7, wherein the act of collecting  
 photoelectrons comprises collecting said photoelectrons in  
 said photo diodes and transferring said collected photoelec-  
 trons to said respective floating diffusion regions.

9. The method of claim 7, wherein the act of collecting  
 photoelectrons is performed simultaneously for every pixel  
 in said imager device.

10. The method of claim 9, wherein the performing a reset  
 operation is done simultaneously for every pixel in said  
 imager device.

8

11. A method of operating an imager device comprising a  
 photo diode and a floating diffusion region coupled through  
 a transfer transistor, the floating diffusion region is coupled  
 to a reset transistor, the method comprising:

activating the transfer transistor;  
 performing a first reset operation to discharge the photo  
 diode and the floating diffusion region;  
 collecting photoelectrons with the photo diode and the  
 floating diffusion region;  
 sampling a voltage level of the floating diffusion region to  
 determine a photosignal;  
 performing a second reset operation to discharge the  
 photo diode and the floating diffusion region; and  
 following the second reset operation, sampling a second  
 voltage level of the floating diffusion region to deter-  
 mine a reset level, wherein a voltage difference  
 between a signal level of the photosignal and the reset  
 level represents the photoelectrons collected by the  
 photo diode.

\* \* \* \* \*