

(12) **United States Patent**
Nixon et al.

(10) **Patent No.:** **US 6,359,274 B1**
(45) **Date of Patent:** **Mar. 19, 2002**

- (54) **PHOTODIODE LIGHT SENSOR**
- (75) **Inventors:** **Robert H. Nixon**, Burbank; **Eric R. Fossum**, La Crescenta, both of CA (US); **Jon H. Bechtel**, Holland, MI (US)
- (73) **Assignee:** **Gentex Corporation**, Zeeland, MI (US)
- (*) **Notice:** Subject to any disclaimer, the term of this patent is extended or adjusted under 35 U.S.C. 154(b) by 0 days.
- (21) **Appl. No.:** **09/307,191**
- (22) **Filed:** **May 7, 1999**

Related U.S. Application Data

- (63) Continuation-in-part of application No. 09/237,107, filed on Jan. 25, 1999, now abandoned.
- (51) **Int. Cl.⁷** **H01J 40/14**
- (52) **U.S. Cl.** **250/214 C; 250/215**
- (58) **Field of Search** 250/214 R, 214 C, 250/214.1, 215; 359/601, 602, 603, 604, 605, 606, 607, 608; 327/514

References Cited

U.S. PATENT DOCUMENTS

- 4,208,668 A 6/1980 Krimmel
- 4,315,159 A 2/1982 Niwa et al.
- 4,465,370 A 8/1984 Yuasa et al.
- 4,669,826 A 6/1987 Itoh et al.
- 4,678,938 A 7/1987 Nakamura
- 4,690,508 A 9/1987 Jacob
- 4,697,883 A 10/1987 Suzuki et al.
- 4,799,768 A 1/1989 Gahan
- 4,819,071 A 4/1989 Nakamura
- 4,916,307 A 4/1990 Nishibe et al.
- 5,036,437 A 7/1991 Macks
- 5,204,778 A 4/1993 Bechtel
- 5,214,274 A 5/1993 Yang
- 5,235,178 A 8/1993 Hegyi
- 5,243,215 A 9/1993 Enomoto et al.

- 5,338,691 A 8/1994 Enomoto et al.
- 5,386,128 A 1/1995 Fossum et al.
- 5,410,455 A 4/1995 Hashimoto
- 5,416,318 A 5/1995 Hegyi
- 5,426,294 A 6/1995 Kobayashi et al.
- 5,451,822 A 9/1995 Bechtel et al.
- 5,471,515 A 11/1995 Fossum et al.
- 5,488,416 A 1/1996 Kyuma
- 5,550,677 A 8/1996 Schofield et al.
- 5,625,210 A 4/1997 Lee et al.
- 5,644,418 A 7/1997 Woodward
- 5,666,028 A 9/1997 Bechtel et al.
- 5,712,685 A 1/1998 Dumas
- 5,760,962 A 6/1998 Schofield et al.
- 5,789,737 A 8/1998 Street
- 5,796,094 A 8/1998 Schofield et al.
- 5,808,350 A 9/1998 Jack et al.
- 5,841,126 A 11/1998 Fossum et al.
- 5,841,159 A 11/1998 Lee et al.
- 5,904,493 A 5/1999 Lee et al.
- 6,027,955 A 2/2000 Lee et al.

FOREIGN PATENT DOCUMENTS

- EP 0 675 345 A2 3/1995
- EP 0 711 683 A1 10/1995
- EP 0 869 032 A2 2/1998
- WO WO 97/35743 10/1997

Primary Examiner—F. L. Evans

(74) *Attorney, Agent, or Firm*—Price, Heneveld, Cooper, DeWitt & Litton

(57) **ABSTRACT**

Light sensors having a wide dynamic range are used in a variety of applications. A wide dynamic range light sensor includes an exposed photodiode light transducer accumulating charge in proportion to light incident over an integration period. Sensor logic determines a light integration period prior to the beginning of integration and the charge is reset. Charge accumulated by the exposed light transducer over the light integration period is measured and a pulse having a width based on the accumulated charge is determined.

22 Claims, 24 Drawing Sheets

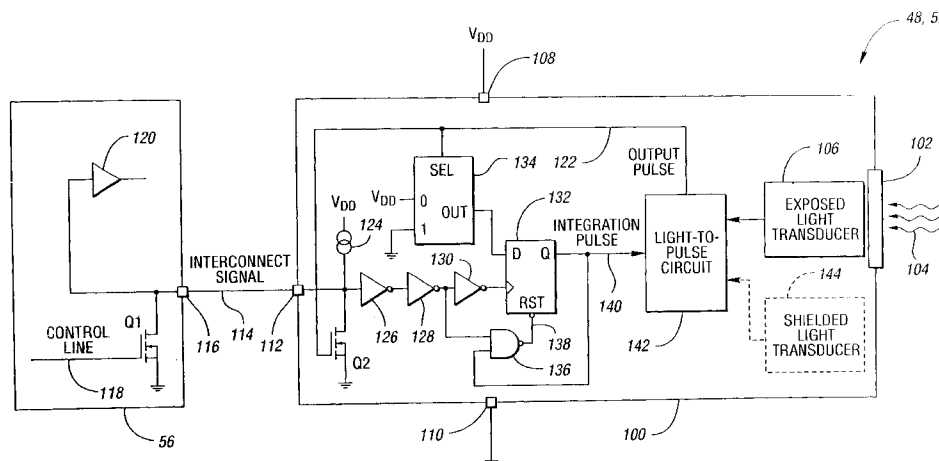

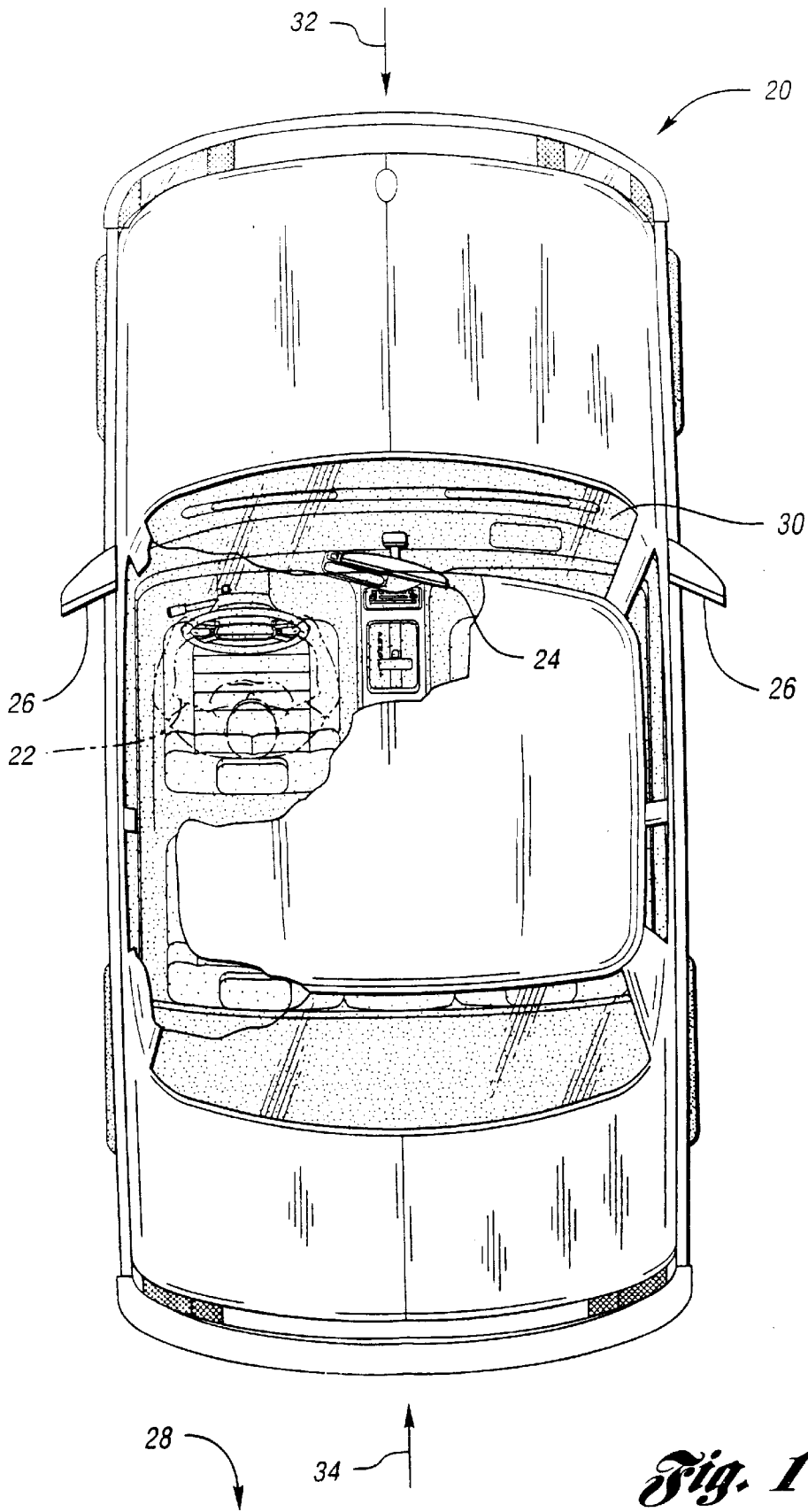

Fig. 1

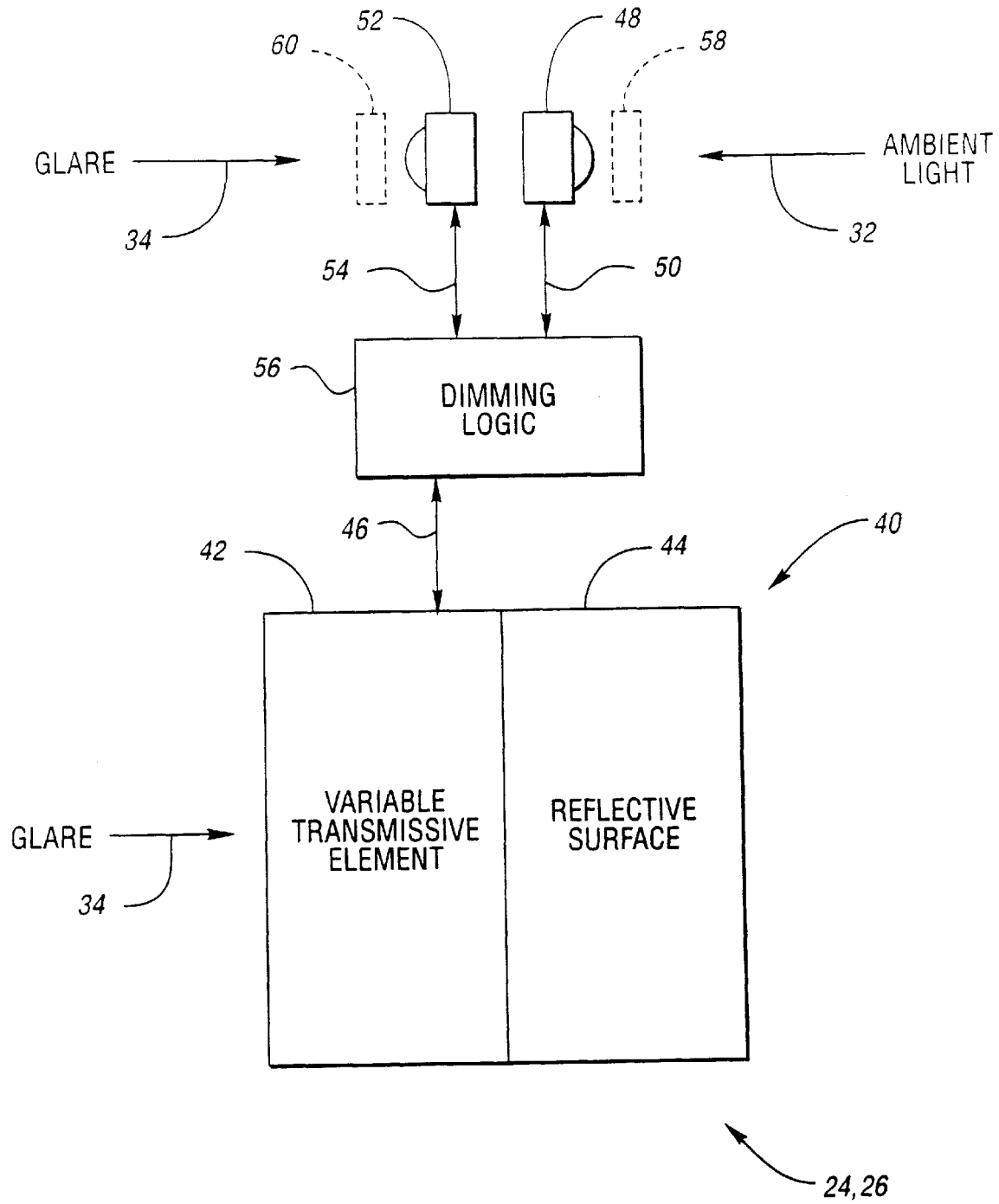

Fig. 2

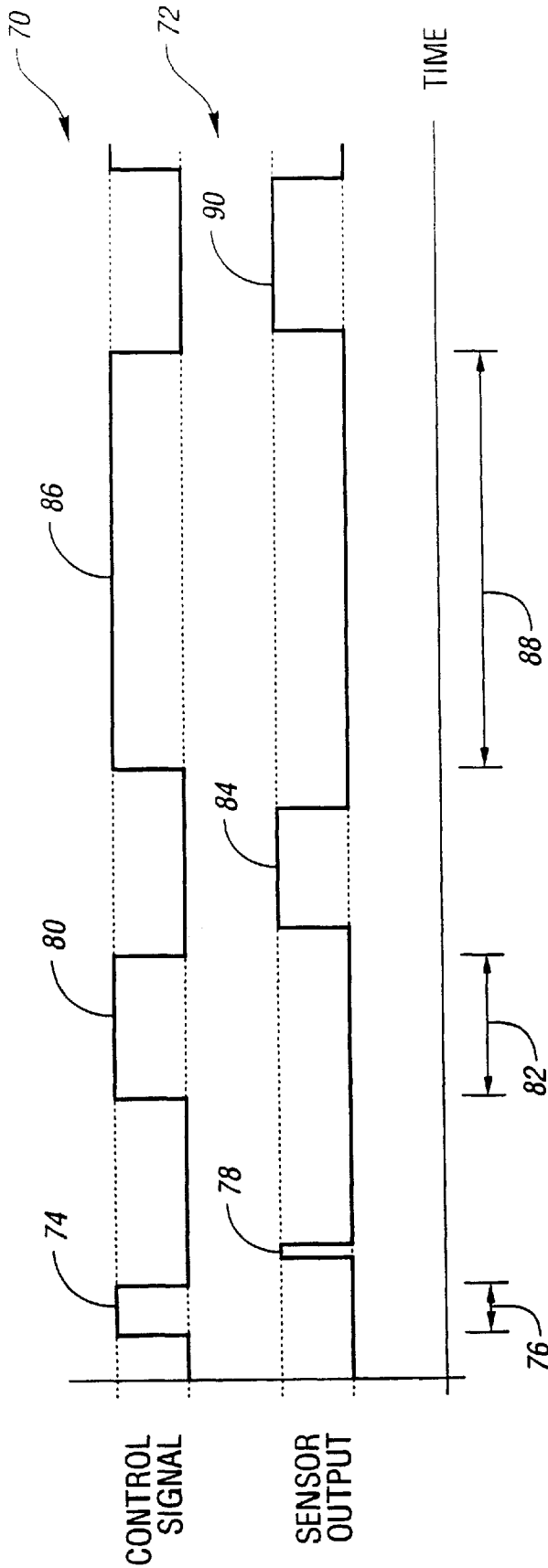

Fig. 3

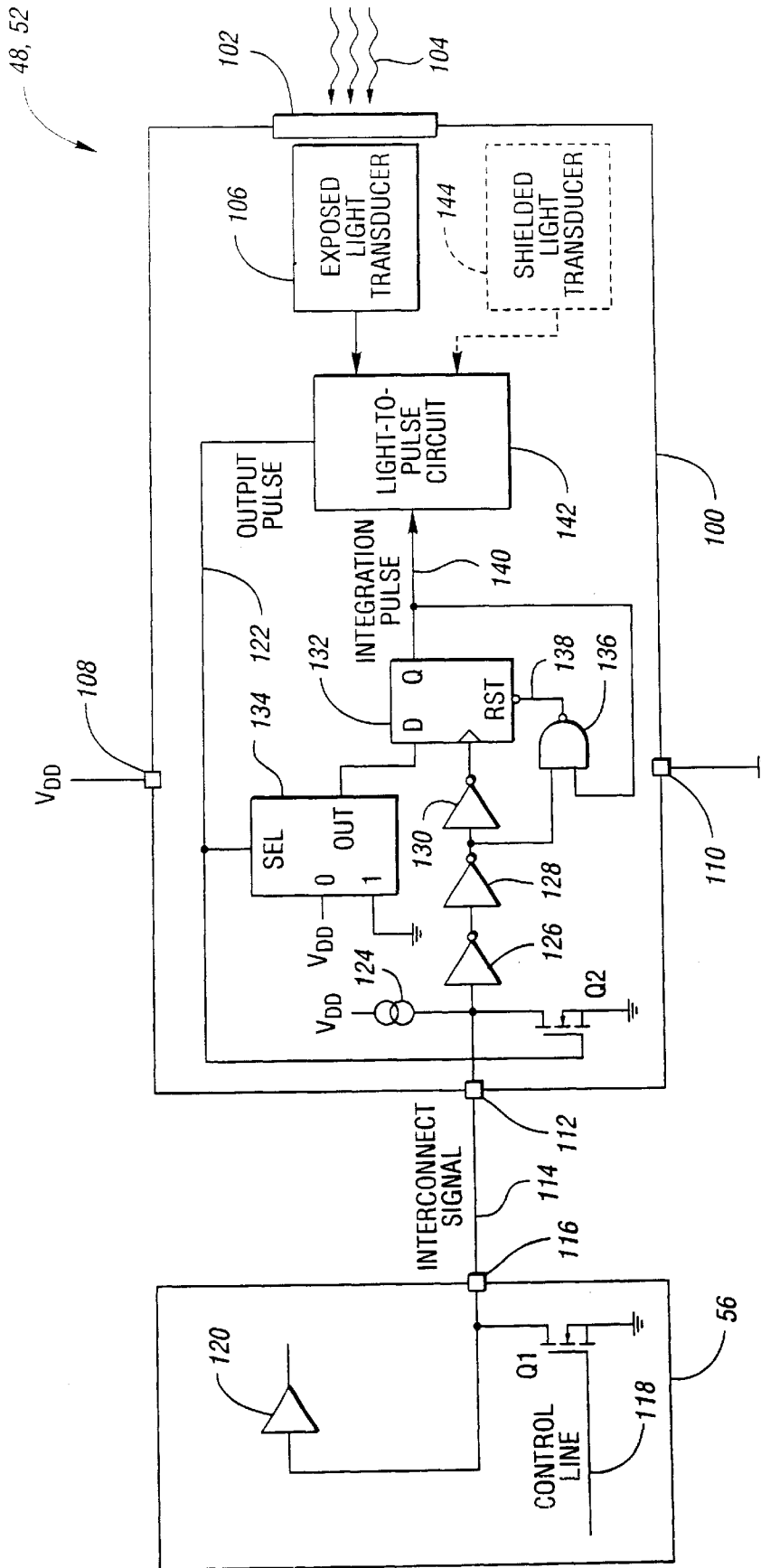

Fig. 4

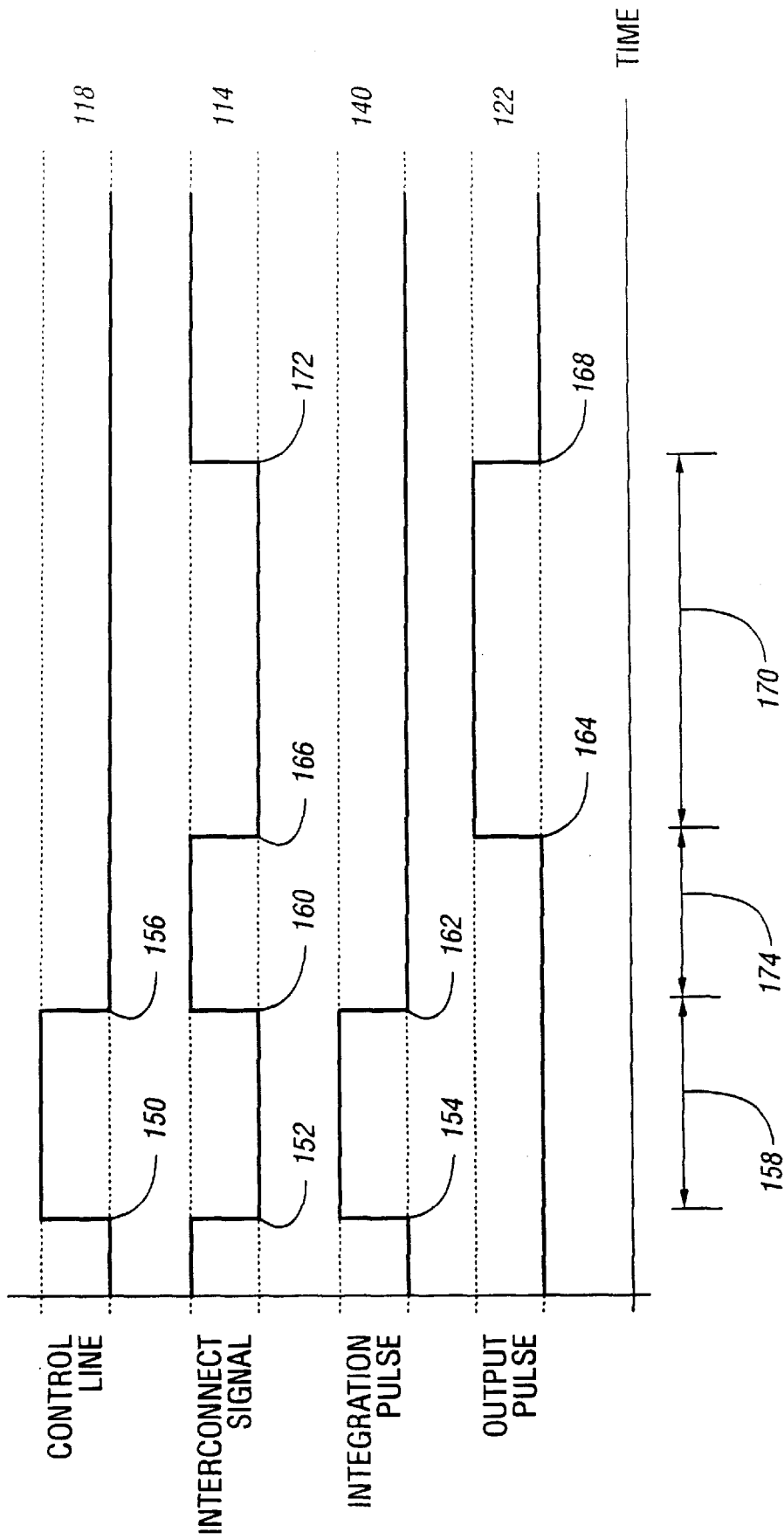

Fig. 5

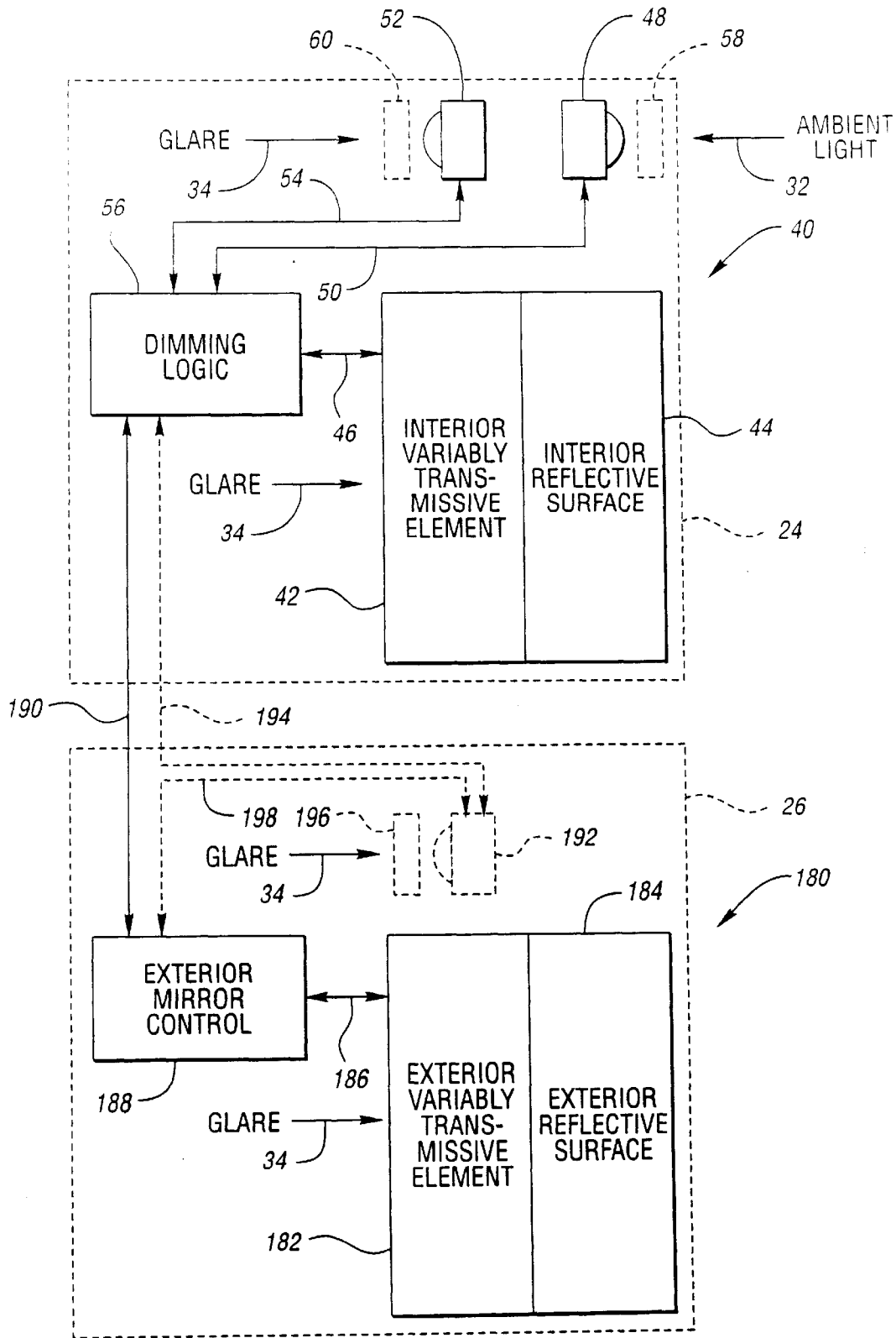

Fig. 6

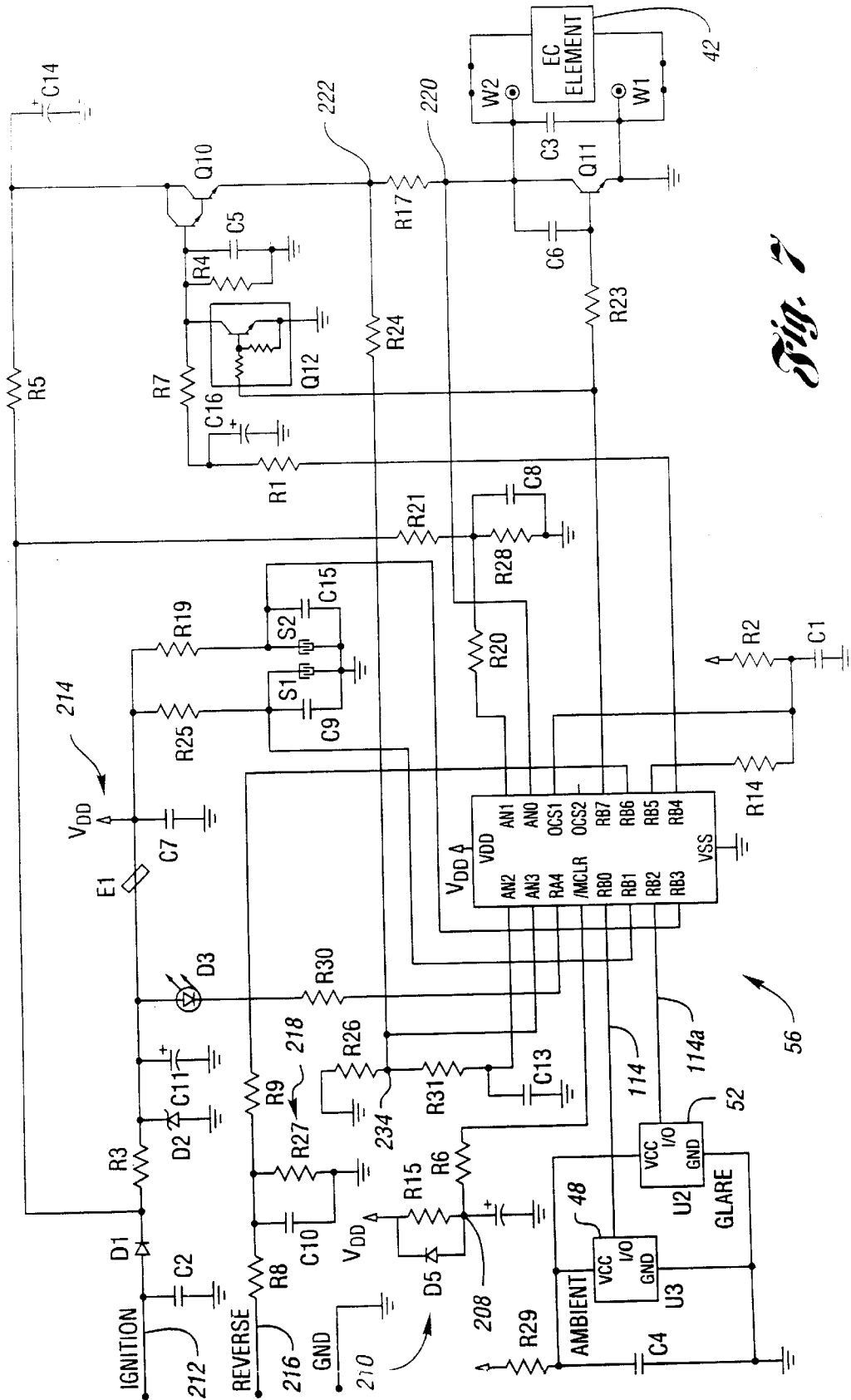

Fig. 7

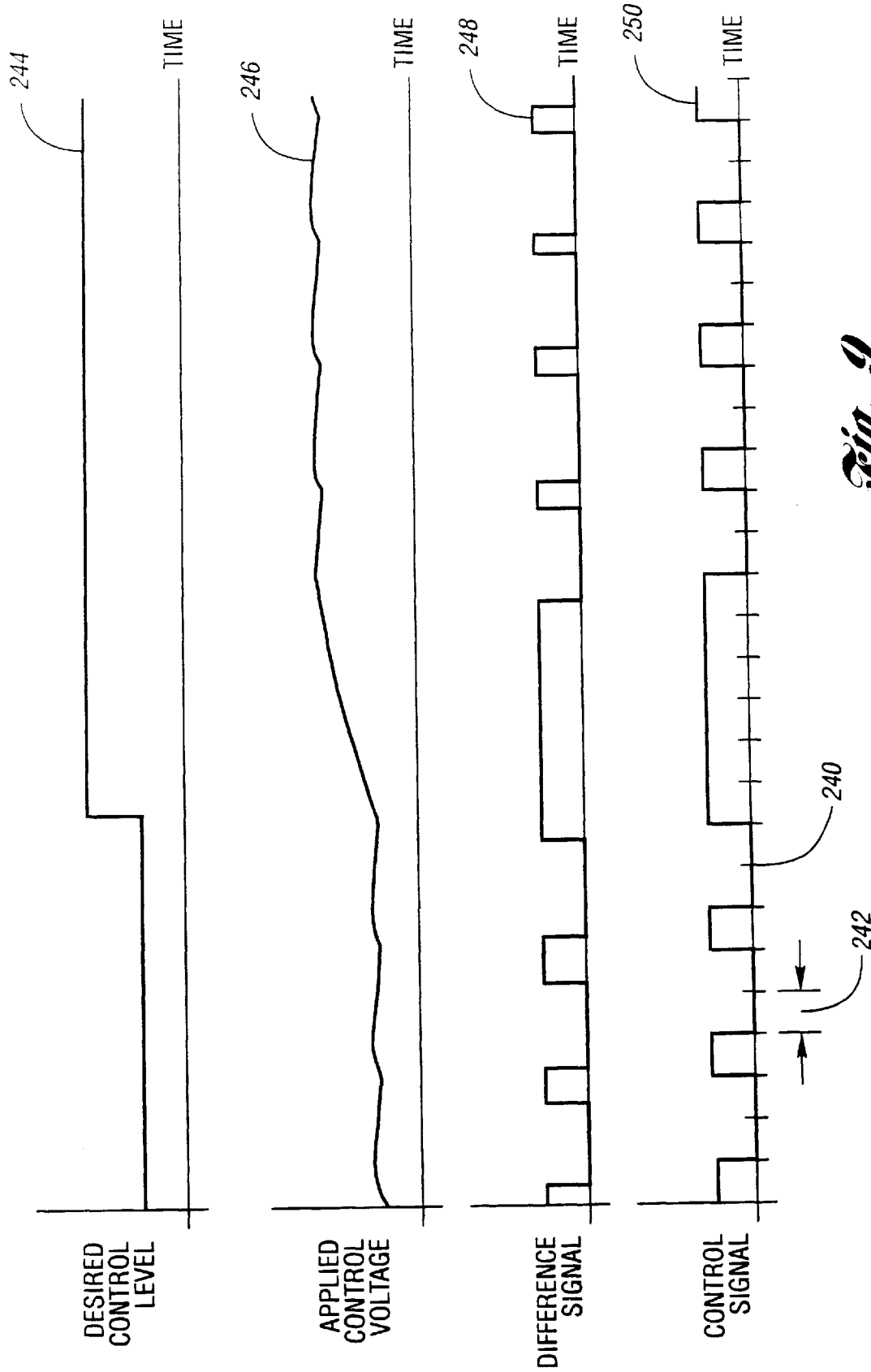

Fig. 9

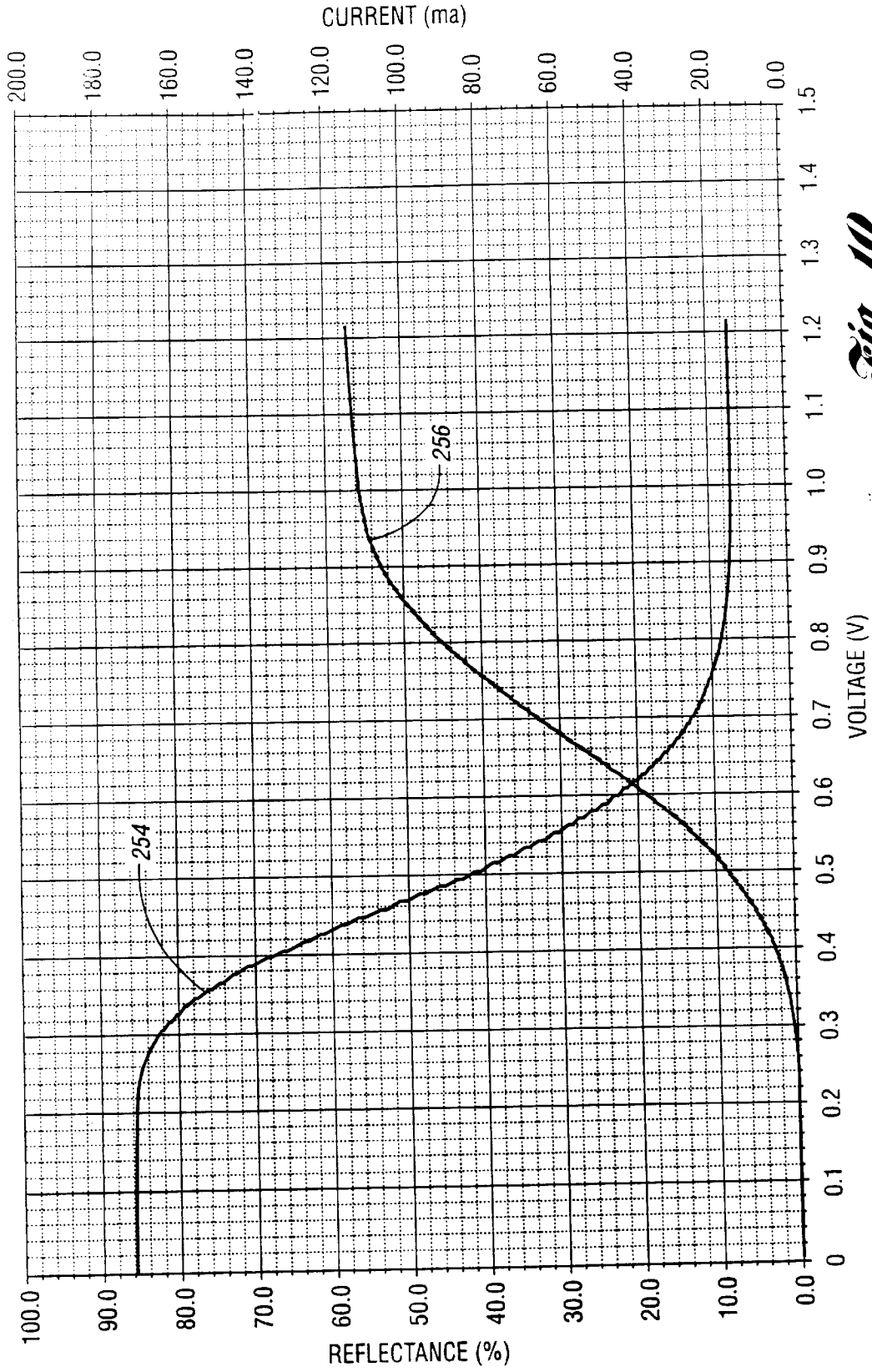
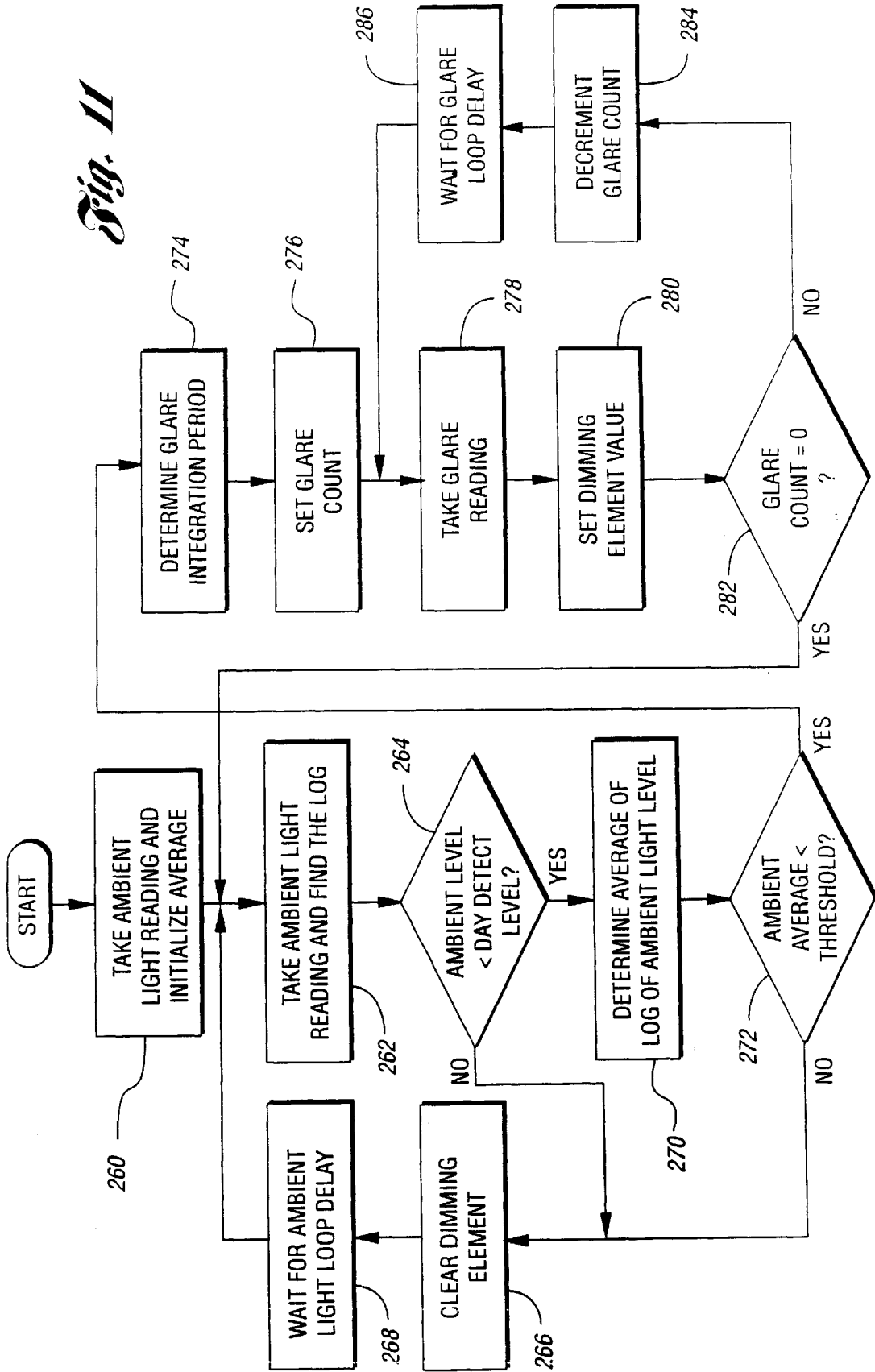

Fig. 10

Fig. 11



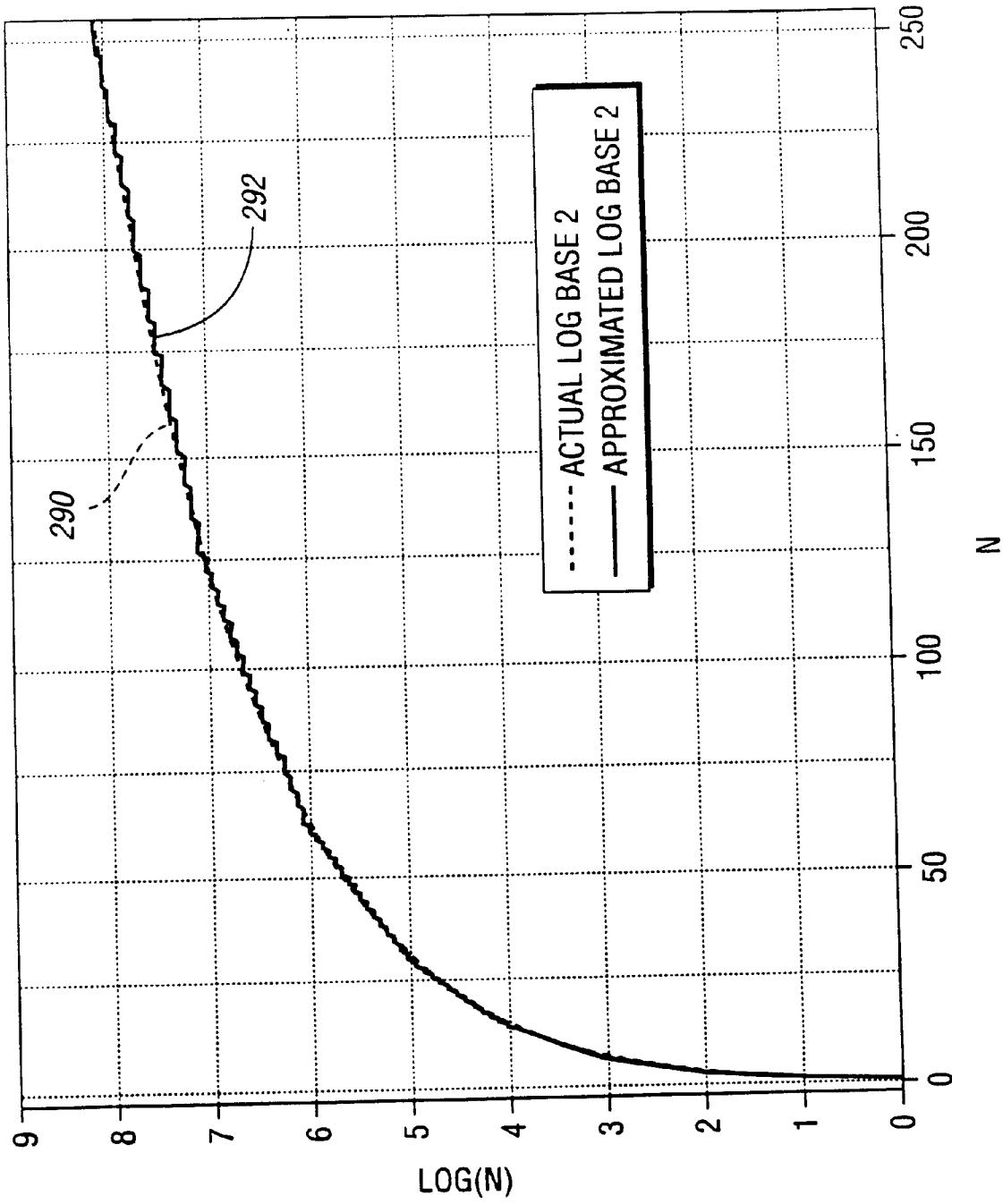

Fig. 12

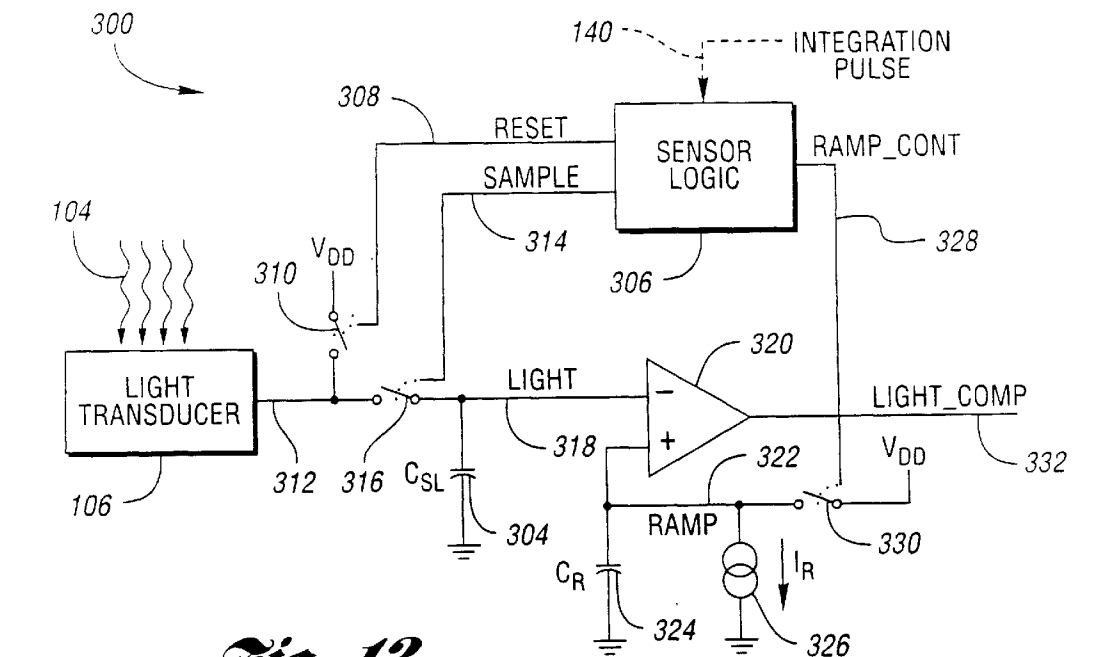

Fig. 13

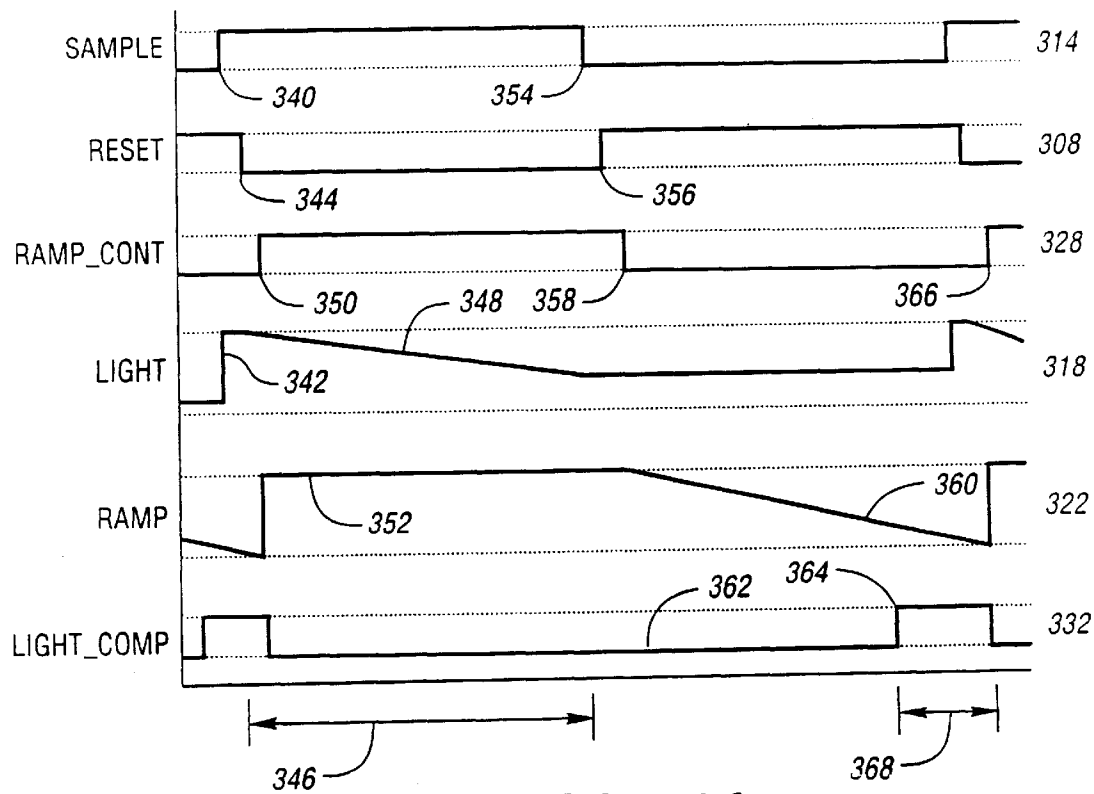

Fig. 14

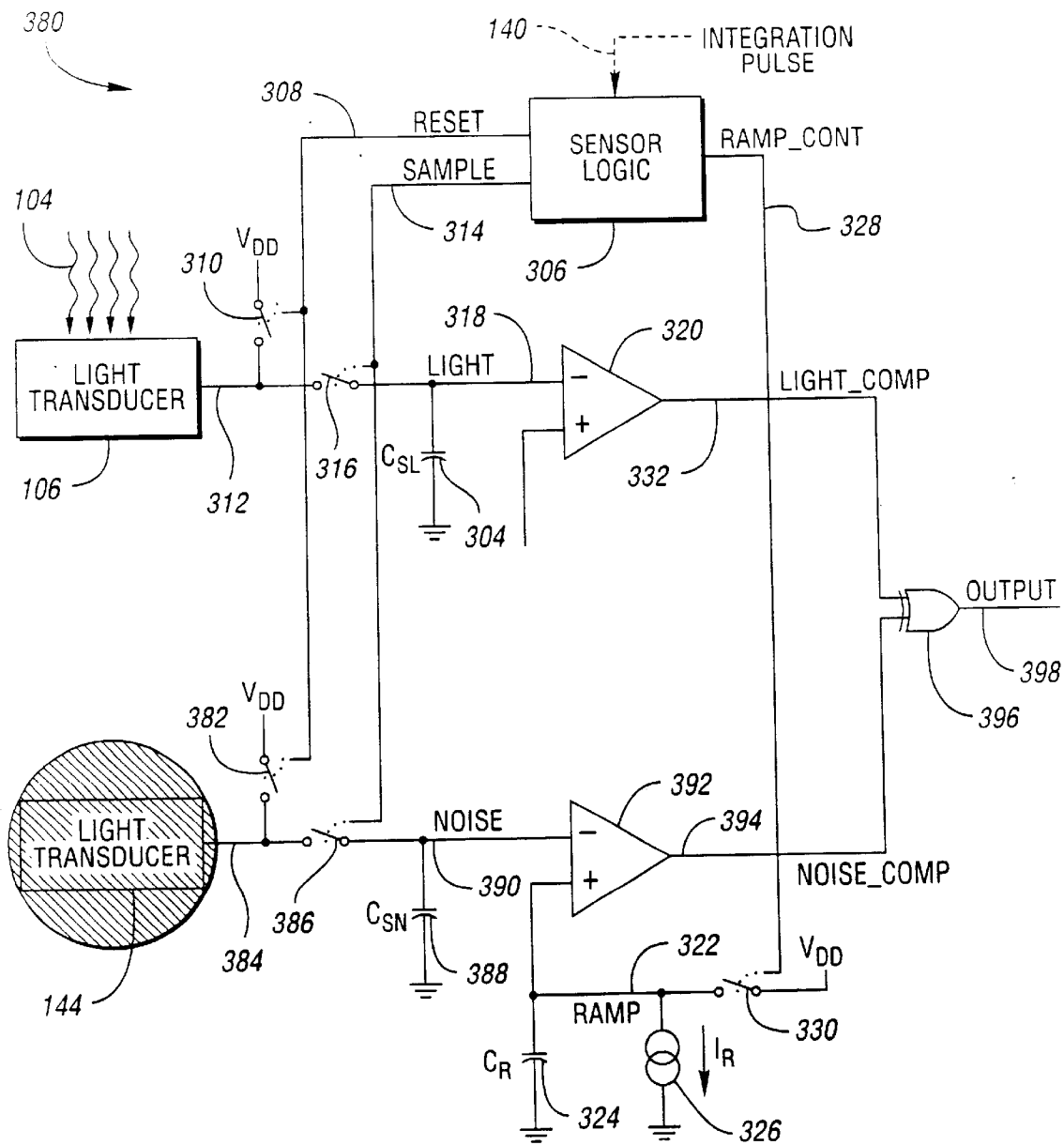

Fig. 15

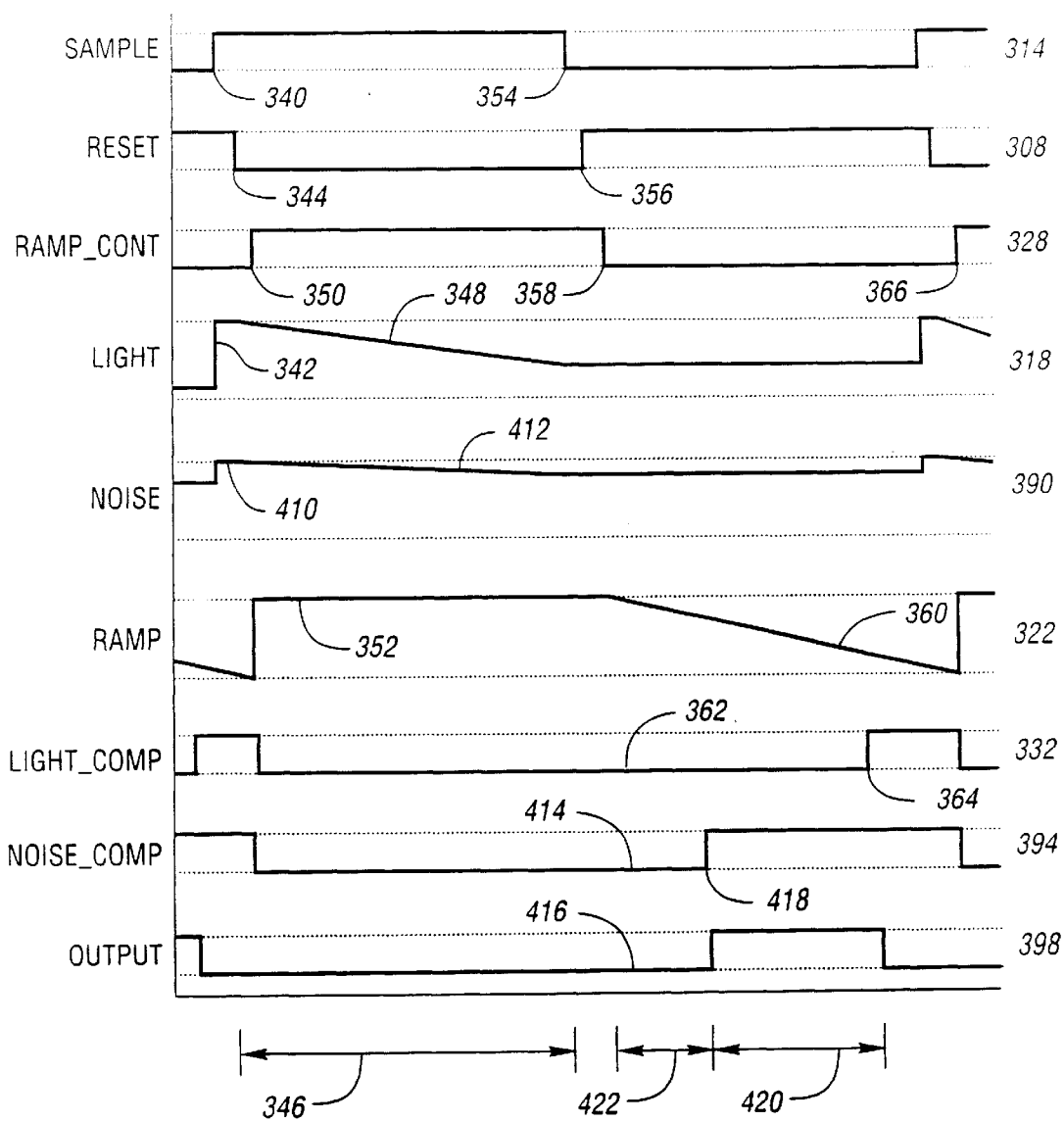

Fig. 16

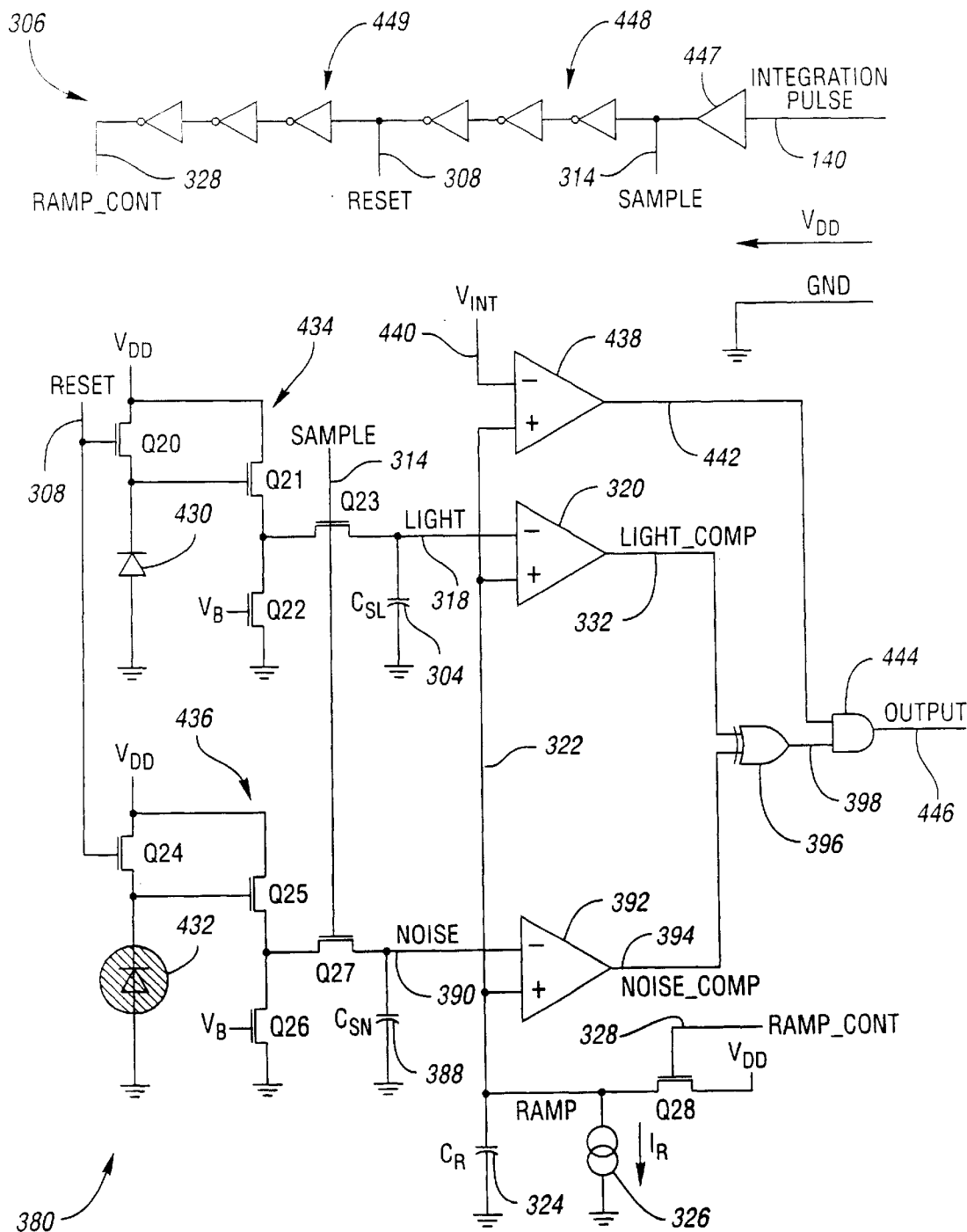

Fig. 17

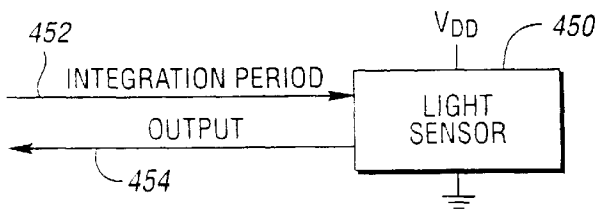

Fig. 18

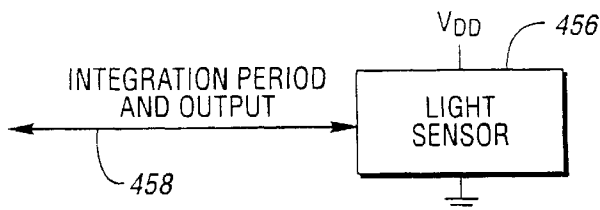

Fig. 19

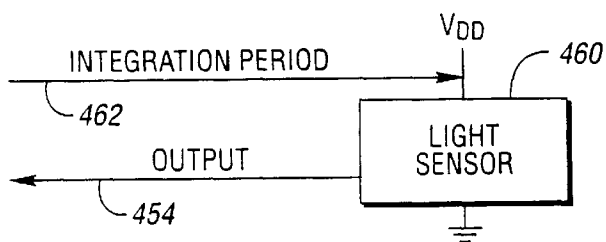

Fig. 20

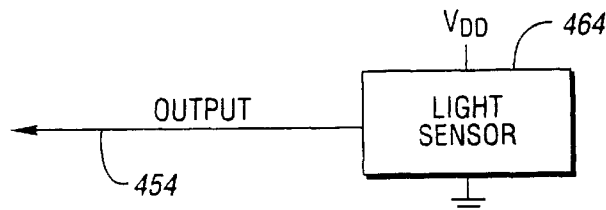

Fig. 21

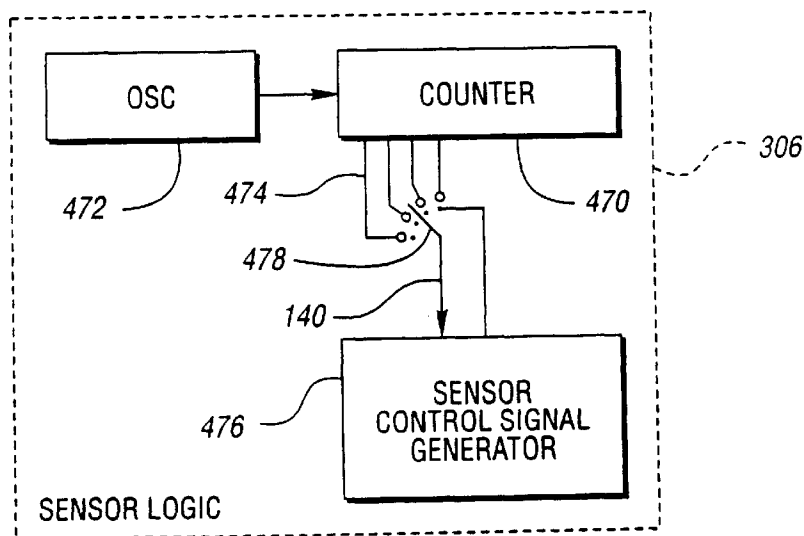
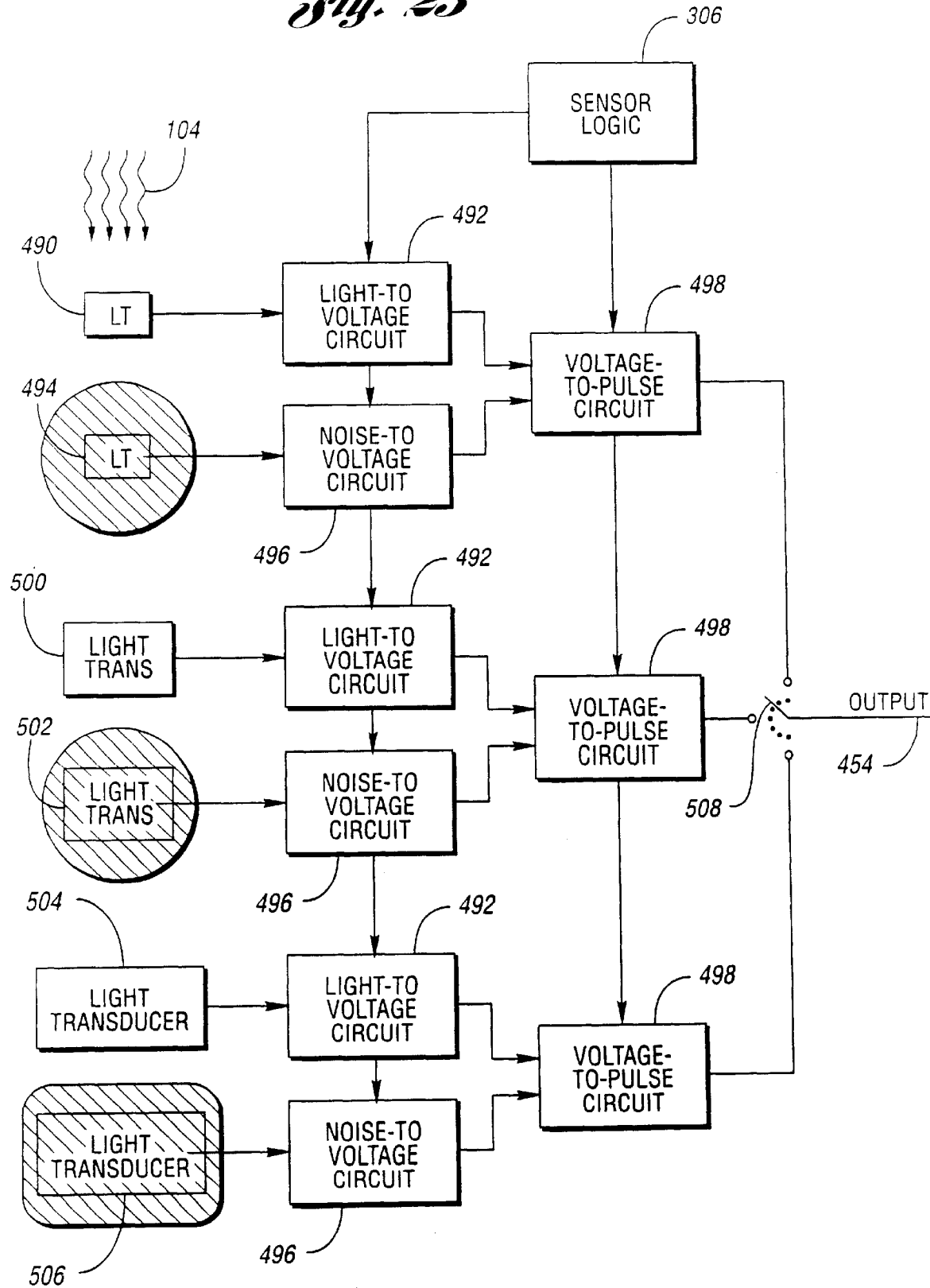

Fig. 22

Fig. 23



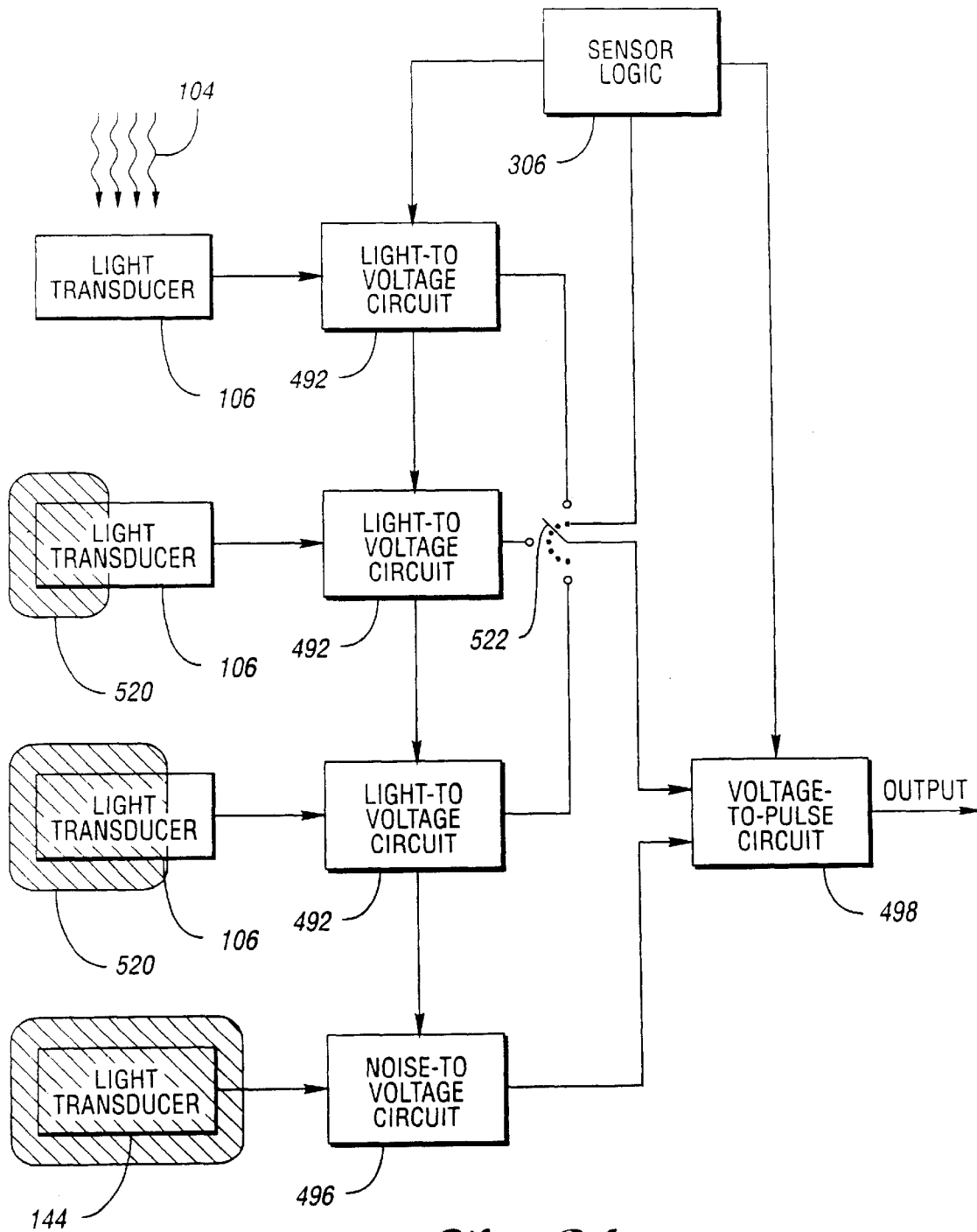

Fig. 24

Fig. 25

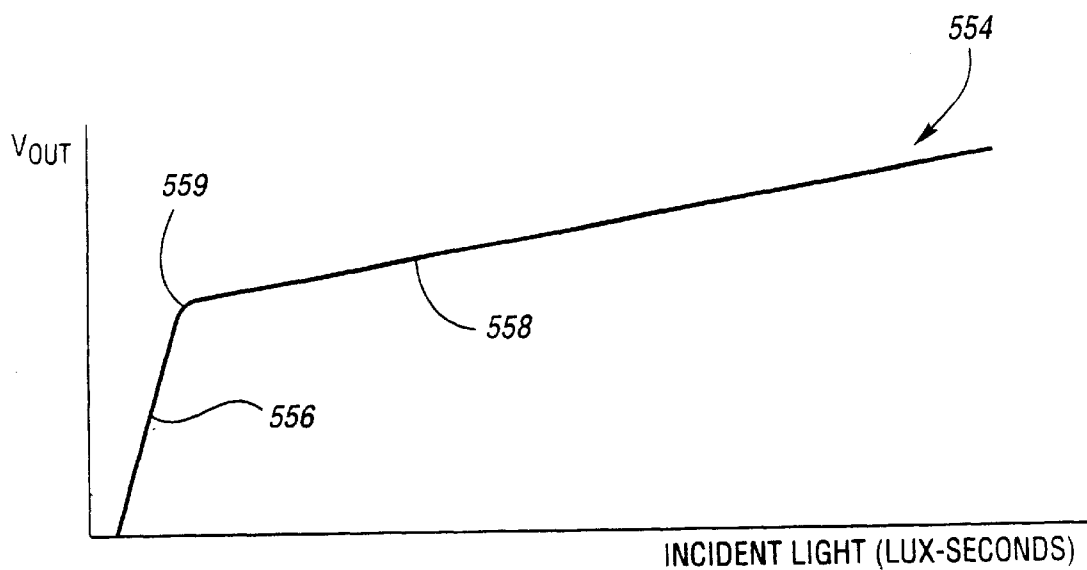
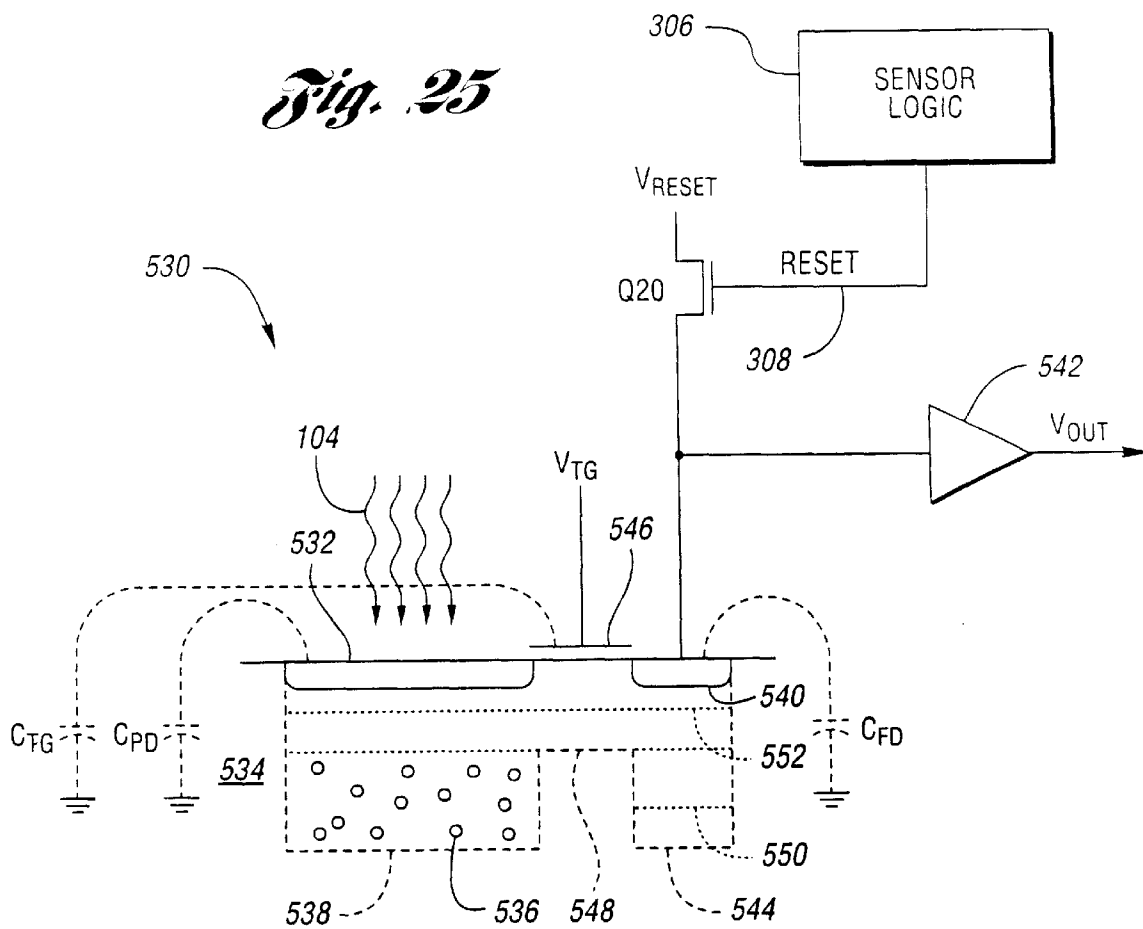

Fig. 26

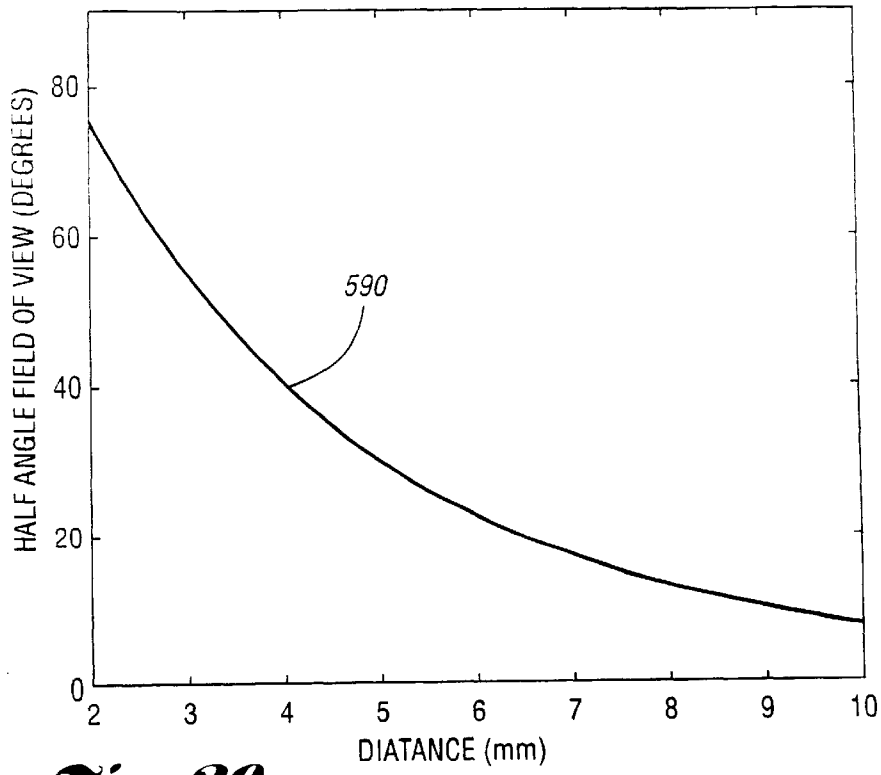

Fig. 29

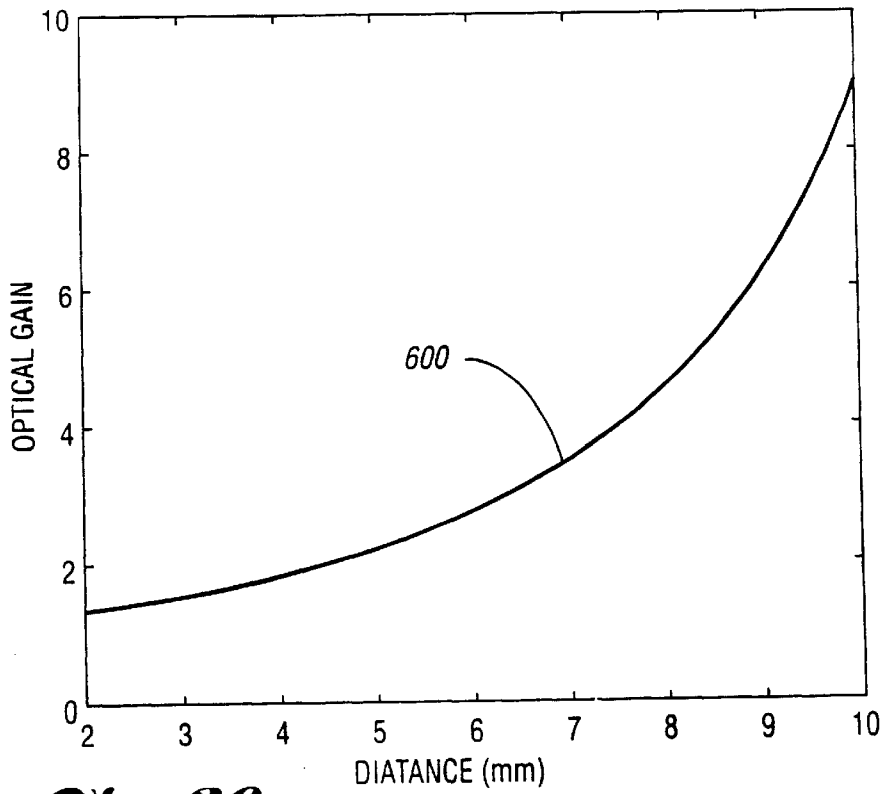

Fig. 30

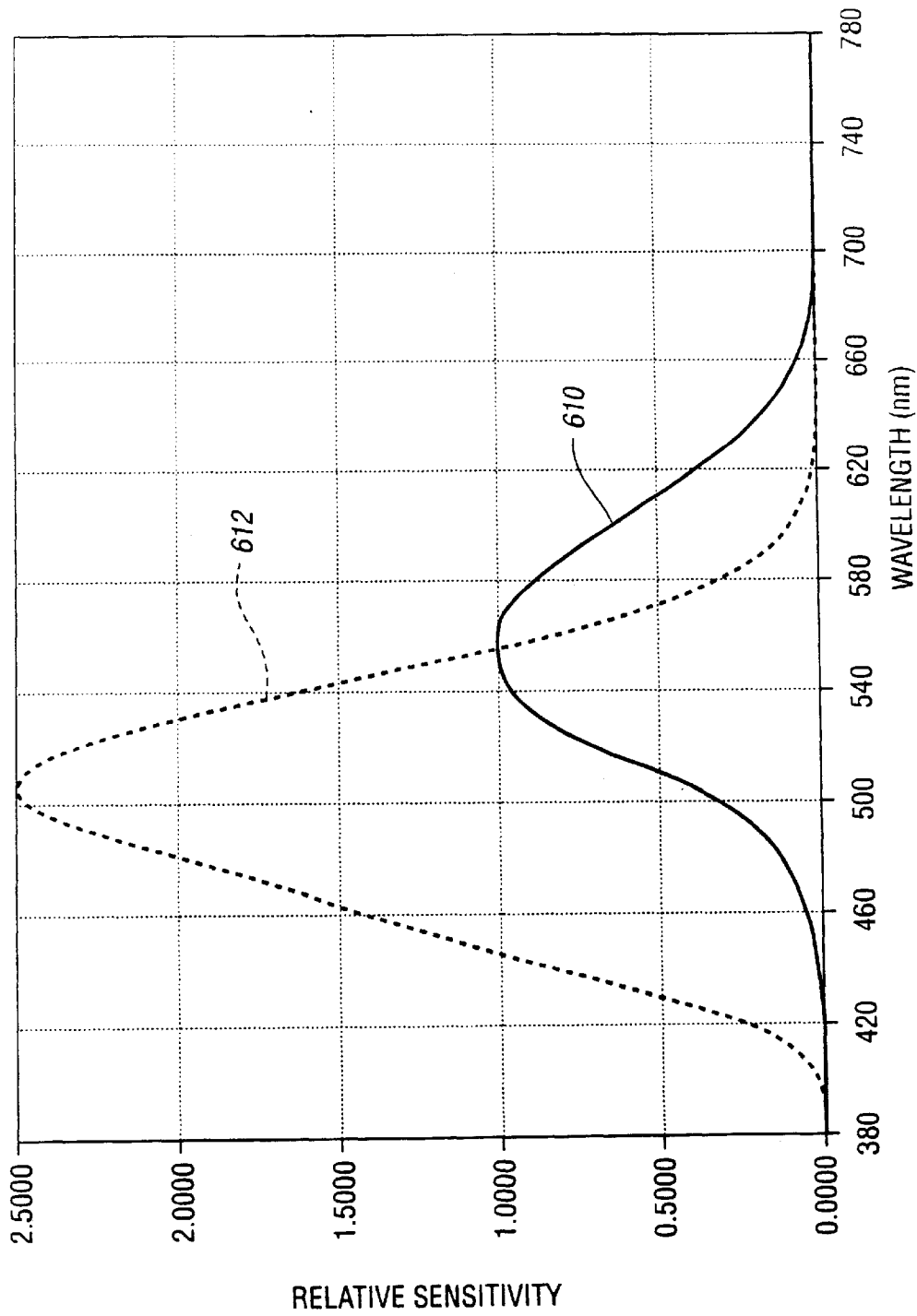

Fig. 31

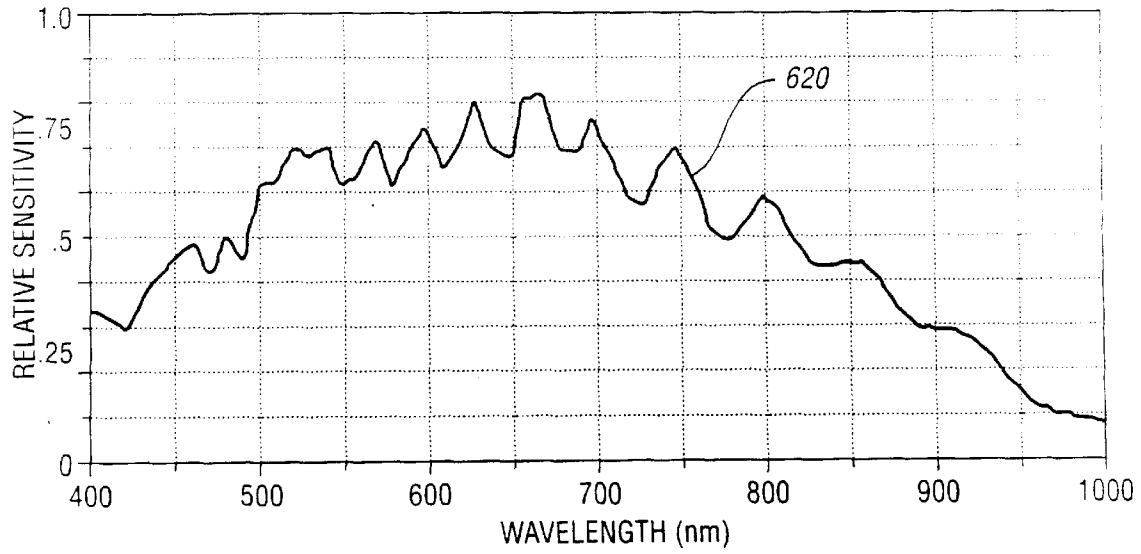

Fig. 32

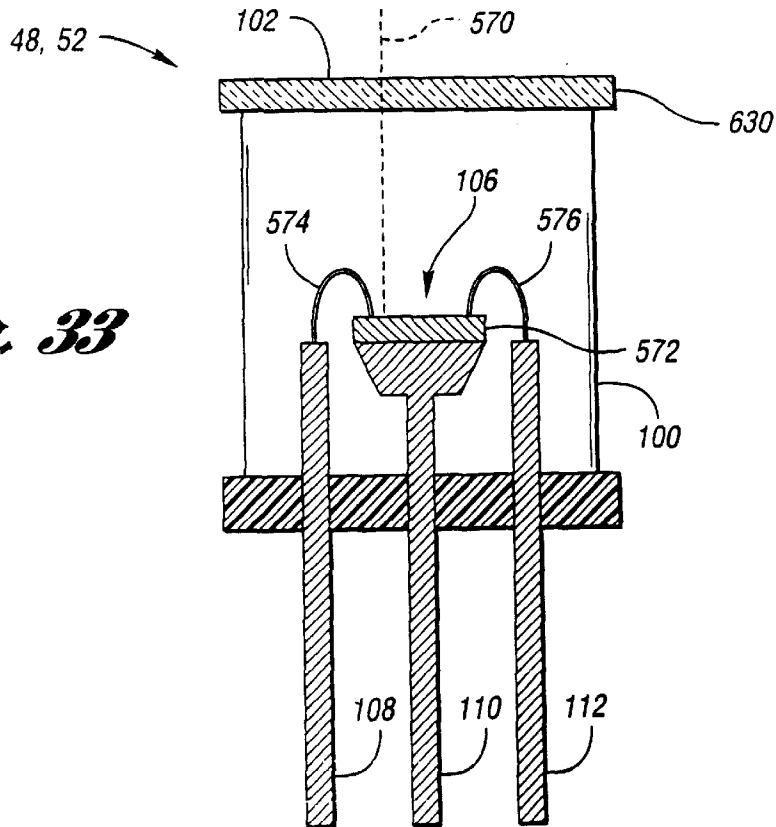

Fig. 33

PHOTODIODE LIGHT SENSOR**CROSS-REFERENCE TO RELATED APPLICATION**

This application is a continuation-in-part of U.S. patent application Ser. No. 09/237,107, filed Jan. 25, 1999, title "Photodiode Light Sensor", now abandoned, the specification of which is expressly incorporated herein by reference in its entirety.

TECHNICAL FIELD

The present invention relates to light sensors incorporating a charge integrating photodiode as a light transducer.

BACKGROUND ART

A light sensor generates an output signal indicating the intensity of light incident upon the light sensor. The light sensor includes a light transducer for converting light into an electrical signal and may also include electronics for signal conditioning, compensation for cross-sensitivities such as temperature, and output signal formatting. Light sensors are used in a wide range of applications including remote sensing, communications, and controls.

One application for light sensors is in automatically dimming vehicle rearview mirrors. Vehicle operators use interior and exterior rearview mirrors to view scenes behind the vehicle without having to face in a rearward direction and to view areas around the vehicle that would otherwise be blocked by vehicle structures. As such, rearview mirrors are an important source of information to the vehicle operator. Bright lights appearing in a scene behind the vehicle, such as from another vehicle approaching from the rear, may create glare in a rearview mirror that can temporarily visually impair or dazzle the operator. This problem is generally worsened during conditions of low ambient light such as occur at night, when the eyes of the vehicle operator have adjusted to the darkness.

Automatically dimming rearview mirrors eliminate the need for the operator to manually switch the mirror. The earliest designs used a single glare sensor facing rearward to detect the level of light striking the mirror. This design proved to be inadequate since the threshold perceived by the operator for dimming the mirror, known as the glare threshold, varied as a function of the ambient light level. An improvement included a second light sensor for detecting the ambient light level. The glare threshold in these systems is based on the amount of ambient light detected. Among the dual sensor designs proposed include those described in U.S. Pat. No. 3,601,614 to Platzer; U.S. Pat. No. 3,746,430 to Brean et al.; U.S. Pat. No. 4,580,875 to Bechtel et al.; U.S. Pat. No. 4,793,690 to Gahan et al.; U.S. Pat. No. 4,886,960 to Molyneux et al.; U.S. Pat. No. 4,917,477 to Bechtel et al.; U.S. Pat. No. 5,204,778 to Bechtel; U.S. Pat. No. 5,451,822 to Bechtel et al.; and U.S. Pat. No. 5,715,093 to Schierbeek et al.; each of which is incorporated herein by reference.

A key element in the design of an automatic dimming mirror is the type of light transducer used to implement ambient light and glare detection. A primary characteristic of interest in selecting a light transducer type is the dynamic range. The ratio between the intensity of bright sunlight and moonlight is roughly 1,000,000:1, indicating the wide range that must be sensed by the ambient light sensor. Both the ambient light and the glare light sensors must operate within the ranges of temperature, humidity, shock, and vibration experienced within a vehicle passenger compartment. If a

sensor is to be mounted in an outside mirror, even harsher operating conditions can be expected. Sensors and support electronics must also be inexpensive to allow the cost of an automatically dimmed mirror to fall within the range deemed acceptable by an automobile purchaser. Transducers should have good noise immunity or be compatible with noise compensation electronics within the sensor for sensitivity at low light levels. Transducers should further have a spectral response similar to the frequency response of the human eye. As a final desirable characteristic, the sensor must be easily integratable into the types of digital control systems commonly found in automotive applications.

Photodiode light sensors incorporate a silicon-based photodiode and conditioning electronics on a single substrate. The photodiode generates charge at a rate proportional to the amount of incident light. This light-induced charge is collected over an integration period. The resulting potential indicates the level of light to which the sensor is exposed over the integration period. Light sensors with integral charge collection have many advantages. By varying the integration time, the sensor dynamic range is greatly extended. Also, the ability to incorporate additional electronics on the same substrate as the photodiode increases noise immunity and permits the sensor output to be formatted for use by a digital circuit. Component integration additionally reduces the system cost. Silicon light sensors are relatively temperature invariant and can be packaged to provide the necessary protection from humidity, shock, and vibration. One disadvantage of silicon-based light transducers is a frequency response different than that of the human eye. A variety of charge integrating photodiode devices have been described including those in U.S. Patent No. 4,916,307 to Nishibe et al.; U.S. Pat. No. 5,214,274 to Yang; U.S. Pat. No. 5,243,215 to Enomoto et al.; U.S. Pat. No. 5,338,691 to Enomoto et al.; and U.S. Pat. No. 5,789,737 to Street; each of which is incorporated herein by reference.

One difficulty with all types of light sensors is the occurrence of operating anomalies at high temperatures. Some devices become extremely non-linear at high temperatures. Some devices may suffer a permanent change in operating characteristics. Devices may even provide completely false readings such as indicating bright light in low light conditions due to excessive thermal noise. Traditionally, the only way to deal with this problem has been to incorporate a temperature sensor and associated electronics into systems that use light sensors.

What is needed is a light sensor with a wide dynamic range that may be incorporated into cost sensitive digital systems such as automatically dimming rearview mirrors. The light sensor should compensate for temperature cross-sensitivity and, preferably, provide an indication of light sensor temperature. A charge integrating light sensor having an externally determined integration period is also desirable.

DISCLOSURE OF INVENTION

It is an object of the present invention to provide a charge integrating light sensor with a wide dynamic range.

Another object of the present invention is to provide a packaged light sensor that is economical to produce.

Still another object of the present invention is to provide a charge integrating light sensor that will easily interface to digital electronics.

Yet another object of the present invention is to provide a charge integrating light sensor with an output signal indicating incident light intensity and sensor temperature.

A further object of the present invention is to provide a charge integrating light sensor with an externally determined integration period.

In carrying out the above objects and other objects and features of the present invention, a light sensor is provided. The light sensor includes an exposed photodiode light transducer accumulating charge in proportion to light incident over an integration period. Sensor logic determines the light integration period prior to the beginning of integration. The charge accumulated in the exposed light transducer at the beginning of the light integration period is reset. The charge accumulated by the exposed light transducer over the light integration period is measured and a pulse having a width based on the accumulated charge is determined.

In an embodiment of the present invention, the light sensor includes a comparator with one input connected to the exposed light transducer and the other input connected to a switched capacitor circuit. The switched capacitor circuit charges a capacitor to a fixed voltage when the switch is closed and discharges the capacitor at a constant rate when the switch is open. The sensor logic closes the switch during the light integration period and opens the switch after the light integration period, thereby creating the pulse at the comparator output. In a refinement, the light sensor further includes a second comparator with one input connected to a fixed voltage and the other input connected to the switched capacitor circuit. The second comparator output inhibits output of the determined pulse if the ramp voltage is less than the fixed voltage.

In another embodiment of the present invention, the light sensor includes a photodiode light transducer shielded from light. The shielded light transducer accumulates charge in proportion to noise over the integration period. The sensor logic resets charge accumulated in the shielded light transducer at the beginning of the light integration period. Charge accumulated by the shielded light transducer over the light integration period is measured and an output pulse having a width based on the difference between the exposed light transducer charge and the shielded light transducer charge is determined.

In still another embodiment of the present invention, the light sensor has an input for receiving an integration signal. Since the noise is dependent on the light sensor temperature, the output pulse can be used to indicate sensor temperature. The output pulse is sent following the end of the received integration signal after a length of time based on the noise level.

In yet other embodiments of the present invention, the light integration period maybe determined from the asserted portion of a control signal received by the sensor logic or may be determined within the sensor control by cycling through a sequence of predetermined time periods.

In a further embodiment of the present invention, the light sensor includes at least one additional exposed photodiode light transducer. Each additional exposed light transducer accumulates charge in proportion to light incident over an integration period at a rate different than the rate of any other exposed light transducer. The sensor logic outputs a pulse having a width based on the accumulated charge for each of the additional exposed light transducers. In one refinement, each exposed light transducer has a different collector area. In another refinement, each exposed light transducer has an aperture with a different light admitting area.

A light sensor package is also provided. The package includes an enclosure having a window for receiving light. The enclosure admits a power pin, a ground pin, and an output pin. Within the enclosure, an exposed photodiode light transducer accumulates charge in proportion to light received through the window incident over the integration

period. A light-to-voltage circuit outputs a light voltage signal based on charge accumulated by the exposed light transducer. A voltage-to-pulse circuit outputs a pulse on the output pin. The width of the pulse is based on the light voltage signal.

A light sensor with a photodiode overlaying a substrate is also provided. The photodiode accumulates charge generated by light incident on the photodiode in a photodiode well formed in a region of the substrate underlying the photodiode. The photodiode has an intrinsic photodiode capacitance. A floating diffusion having an intrinsic floating diffusion capacitance is also formed in the substrate. The floating diffusion has a diffusion well formed in a region of the substrate underlying the floating diffusion when the charge is reset. The floating diffusion eliminates charge in the diffusion well when the charge is reset. The floating diffusion charge determines an output potential. A transmission gate having an intrinsic transmission gate capacitance is placed between the photodiode and the floating diffusion. The transmission gate forms a transmission well in a region of the substrate between the region of the substrate underlying the photodiode and the region of the substrate underlying the floating diffusion. The transmission well has a depth shallower than the photodiode well and the diffusion well. When the charge is reset, charge in the photodiode well above the depth of the transmission well flows through the transmission well, through the floating diffusion, and is eliminated. During a light integration period, charge produced by light incident on the photodiode flows through the transmission well and into the diffusion well, producing output voltage inversely proportional to the floating diffusion capacitance. Once the diffusion well is filled to the depth of the transmission well, charge produced by light incident on the photodiode fills the photodiode well, the transmission well, and the diffusion well, producing output voltage inversely proportional to the sum of the floating diffusion capacitance, the photodiode capacitance, and the transmission gate capacitance. This dual capacitance provides a first sensitivity during charge accumulation in the diffusion well only and a second sensitivity during charge accumulation in the diffusion well, the transmission well, and the photodiode well. The first sensitivity is greater than the second sensitivity.

In an embodiment, the light sensor includes an anti-bloom gate between the photodiode and a source voltage diffusion. The anti-bloom gate defines an anti-blooming well formed in a region of the substrate between the region of the substrate underlying the photodiode and the source voltage diffusion. The anti-blooming well has a depth shallower than the transmission well.

The above objects and other objects, features, and advantages of the present invention are readily apparent from the following detailed description of the best mode for carrying out the invention when taken in connection with the accompanying drawings.

BRIEF DESCRIPTION OF DRAWINGS

FIG. 1 is a drawing illustrating vehicle rearview mirrors that may incorporate the present invention;

FIG. 2 is a block diagram of an embodiment of the present invention;

FIG. 3 is a timing diagram illustrating integration control and sensor output for a light sensor that may be used to implement the present invention;

FIG. 4 is a schematic diagram of circuitry permitting dimming logic and a light sensor to be interconnected by a single line carrying both integration control and sensor output;

FIG. 5 is a timing diagram illustrating operation of the circuitry FIG. 4;

FIG. 6 is a block diagram of a rearview mirror system with interior and exterior rearview mirrors according to embodiments of the present invention;

FIG. 7 is a schematic diagram illustrating an embodiment of the dimming logic;

FIG. 8 is a schematic diagram illustrating operation of electrochromic element transmittance control;

FIG. 9 is a timing diagram illustrating electrochromic element transmittance control;

FIG. 10 is a graph indicating dimmer reflectance as a function of dimmer control signal duty cycle;

FIG. 11 is a flow diagram illustrating operation of dimming logic according to an embodiment of the present invention;

FIG. 12 is a graph illustrating binary logarithmic approximation implemented in an embodiment of the dimming logic;

FIG. 13 is a schematic diagram illustrating operation of a light sensor having a pulse output according to an embodiment of the present invention;

FIG. 14 is a timing diagram illustrating operation of the light sensor of FIG. 13;

FIG. 15 is a schematic diagram illustrating operation of a light sensor with noise compensation according to an embodiment of the present invention;

FIG. 16 is a timing diagram illustrating operation of the light sensor of FIG. 15;

FIG. 17 is a schematic diagram of an implementation of the light sensor of FIG. 15 using photodiodes as light transducers;

FIGS. 18–21 are block diagrams of various embodiments for light sensor packaging, output, and control;

FIG. 22 is a block diagram of sensor logic for internally determining the integration period signal;

FIG. 23 is a block diagram illustrating the use of light transducers having different effective areas to achieve increased dynamic range according to an embodiment of the present invention;

FIG. 24 is a block diagram illustrating the use of light transducers having different apertures to achieve increased dynamic range according to an embodiment of the present invention;

FIG. 25 is a schematic diagram illustrating different transducer capacitances for different amounts of light-induced charge to achieve increased dynamic range according to an embodiment of the present invention;

FIG. 26 is a graph of the output potential as a function of accumulated incident light for the transducer of FIG. 25;

FIG. 27 is a schematic diagram illustrating a photodiode transducer incorporating an anti-bloom gate according to an embodiment of the present invention;

FIG. 28 is a drawing illustrating an enclosure for a light sensor according to an embodiment of the present invention;

FIG. 29 is a graph illustrating light sensor field of view as a function of light transducer distance from the lens;

FIG. 30 is a graph illustrating light sensor optical gain as a function of light transducer distance from the lens;

FIG. 31 is a graph illustrating frequency response of the human eye;

FIG. 32 is a graph illustrating frequency response of a typical light transducer; and

FIG. 33 is a drawing of an enclosure incorporating an infrared filter according to an embodiment of the present invention.

BEST MODE FOR CARRYING OUT THE INVENTION

Referring now to FIG. 1, a drawing illustrating vehicle rearview mirrors that may incorporate the present invention is shown. Vehicle 20 is driven by operator 22. Operator 22 uses interior rearview mirror 24 and one or more exterior rearview mirrors 26 to view a rearward scene, shown generally by 28. Most of the time, operator 22 is looking forward through windshield 30. The eyes of operator 22 therefore adjust to ambient light 32 coming from a generally forward direction. A relatively bright light source in rearward scene 28 may produce light which can reflect from mirrors 24,26 to temporarily visually impair, distract, or dazzle operator 22. This relatively strong light is known as glare 34.

To reduce the impact of glare 34 on operator 22, the reflectance of mirrors 24,26 may be reduced. Prior to automatically dimming mirrors, interior rearview mirror 24 would contain a prismatic reflective element that could be manually switched by operator 22. Automatically dimming mirrors include a sensor for glare 34 and, typically, for ambient light 32, and dim one or more mirrors 24,26 in response to the level of glare 34.

Referring now to FIG. 2, a block diagram of an embodiment of the present invention is shown. A dimming element, shown generally by 40, includes variable transmittance element 42 and reflective surface 44. Dimming element 40 is positioned such that reflective surface 44 is viewed through variable transmittance element 42. Dimming element 40 exhibits variable reflectance of light in response to dimming element control signal 46. Ambient light sensor 48 is positioned to receive ambient light 32 from generally in front of vehicle 20. Ambient light sensor 48 produces discrete ambient light signal 50 indicating the amount of ambient light 32 incident on ambient light sensor 48 over an ambient light integration period. Glare sensor 52 is positioned to detect glare 34 from generally behind vehicle 20 and may optionally be placed to view glare 34 through variable transmittance element 42. Glare sensor 52 produces discrete glare signal 54 indicating the amount of glare 34 incident on glare sensor 52 over a glare integration period. Dimming logic 56 receives ambient light signal 50 and determines an ambient light level. Dimming logic 56 determines the glare integration period based on the level of ambient light 32. Dimming logic 56 receives glare signal 54 and determines the level of glare 34. Dimming logic 56 outputs dimming element control signal 46, setting the reflectance of dimming element 40 to reduce the effects of glare 34 perceived by operator 22.

Either glare sensor 52, ambient light sensor 48 or, preferably, both are semiconductor light sensors with integral charge collection. Such sensors include light transducers which convert incident light into charge. This charge is collected over an integration period to produce a potential which is converted by sensor 48,52 into a discrete output. Designs suitable for this application are described in U.S. Pat. No. 4,916,307 entitled "Light Intensity Detecting Circuit With Dark Current Compensation" by Nishibe et al.; and U.S. Pat. No. 5,214,274 entitled "Image Sensor Array With Threshold Voltage Detectors And Charged Storage Capacitors" to Yang; each of which is incorporated herein by reference. Preferred embodiments for light sensors 48,52 are described with regard to FIGS. 13–33 below.

One difficulty with silicon-based sensors is the difference in spectral sensitivity between silicon and the human eye. Ambient light filter **58** may be placed before or incorporated within ambient light sensor **50**. Similarly, glare filter **60** may be placed before or incorporated within glare sensor **52**. Filters **58,60** attenuate certain portions of the spectrum that may include visible light, infrared, and ultraviolet radiation such that light striding sensors **48,52** combines with the frequency response of light transducers within sensors **48,52** to more closely approximate the response of the human eye and to compensate for tinting in vehicle windows such as windshield **30**. The use of filters **58,60** to compensate for the spectral sensitivity of light transducers within sensors **48,52** is described with regards to FIGS. **31–33** below.

Variable transmittance element **42** may be implemented using a variety of devices. Dimming may be accomplished mechanically as described in U.S. Pat. No. 3,680,951 titled “Photoelectrically-Controlled Rear-View Mirror” to Jordan et al.; and U.S. Pat. No. 4,443,057 titled “Automatic Rear-view Mirror For Automotive Vehicles” to Bauer et al.; each of which is incorporated herein by reference. Variable transmittance element **42** may be formed using liquid crystal cells as is described in U.S. Pat. No. 4,632,509 titled “Glare-Shielding Type Reflector” to Ohmi et al., which is incorporated herein by reference. Preferably, variable transmittance element **42** is an electrochromic cell which varies transmittance in response to an applied control voltage such as is described in U.S.

Pat. No. 4,902,108 titled “Single-Compartment, Self-Erasing, Solution-Phase Electrochromic Devices, Solutions For Use Therein, And Uses Thereof” to Byker, which is incorporated herein by reference. Many other electrochromic devices may be used to implement dimming element **40**, some of which are mentioned in the Background Art section of this application. As will be recognized by one of ordinary skill in the art, the present invention does not depend on the type or construction of dimming element **40**. If dimming element **40** includes electrochromic variable transmittance element **42**, reflective surface **44** may be incorporated into variable transmittance element **42** or may be external to variable transmittance element **42**.

Each interior rearview mirror **24** and exterior rearview mirror **26** must include dimming element **40** for automatic dimming. Preferably, interior rearview mirror **24** also includes dimming logic **56**, light sensors **48,52**, and, if used, filters **58** and **60**. Various embodiments for controlling exterior rearview mirrors **26** are described with regard to FIG. **6** below.

Referring now to FIG. **3**, a timing diagram illustrating integration control and sensor output for a light sensor that may be used to implement the present invention is shown. Charge accumulating light sensors **48,52** exhibit increased dynamic range through variable integration periods. A control signal, shown generally by **70**, is used to specify the integration period. The resulting sensor output, shown generally by **72**, includes an output pulse for each integration period. The total amount of light-induced charge which can be effectively measured is limited. Therefore, in the presence of bright light, a short integration time is desirable to prevent saturation. However, if a short integration time is used in low light conditions, the charge signal may be lost in noise inherent in sensor **48,52**.

Control signal **70** includes a sequence of integration periods having varying lengths. In the example shown in FIG. **3**, short integration pulse **74** having short integration period **76** is generated. A semiconductor light sensor may

output a short pulse in a completely dark environment due to noise. Therefore, any pulse in sensor output **72**, such as short signal pulse **78**, having a duration less than a threshold is ignored. Next, medium integration pulse **80** having medium integration period **82** is generated. Resulting medium signal pulse **84** has a duration indicative of the amount of light incident on sensor **48,52** during medium integration period **82**. Long integration pulse **86** having long integration period **88** is generated. If light sensor **48,52** is sufficiently bright, saturation will result. Therefore, long signal pulse **90** having a duration greater than a threshold is also ignored.

Control signal **70** may be generated outside of light sensor **48,52** or may be generated by control logic within light sensor **48,52**. If generated externally, control signal **70** and sensor output **72** may share a common signal line or may use separate signal lines. Various options and embodiments are described with regard to FIGS. **4–28** below.

Referring now to FIG. **4**, a schematic diagram of circuitry permitting dimming logic and a light sensor to be interconnected by a single line carrying both integration control and sensor output is shown. Light sensor **48,52** includes enclosure **100** with window **102** admitting light **104** incident on exposed light transducer **106**. Enclosure **100** admits power pin **108**, ground pin **110**, and signal pin **112**. The use of only three pins **108,110,112** greatly reduces the cost of light sensor **48,52**. A three-pin package that may be used to implement light sensor **48,52** is described with regards to FIG. **28** below.

Light sensor **48,52** is connected to dimming logic **56** through interconnection signal **114** between signal pin **112** in light sensor **48,52** and signal pin **116** in dimming logic **56**. As will be described below, signal pins **112,116** are tri-state ports permitting interconnect signal **114** to provide both an input to light sensor **48,52** and an output from light sensor **48,52**. Dimming logic **56** may include FET **Q1** connected between signal pin **116** and ground. FET **Q1** is controlled by control line **118** connected to the base of **Q1**. Buffer **120** is also connected to signal pin **116**.

Within light sensor **48,52**, FET **Q2** is connected between signal pin **112** and ground. FET **Q2** is controlled by output pulse **122** connected to the gate of **Q2**. Constant current source **124** is connected to signal pin **112** so that if neither **Q1** or **Q2** are on, interconnect signal **114** is pulled high. Constant current source **124** nominally sources about 0.5 mA to pull up interconnect signal **114**. The input of Schmidt trigger inverter **126** is connected to signal pin **112**. Schmidt trigger inverter **126** is followed by inverters **128** and **130** in series. The output of inverter **130** clocks D flip-flop **132**. The output of multiplexer **134** is connected to the D input of flip-flop **132**. The select input of multiplexer **134** is driven by output pulse **122** such that when output pulse **122** is asserted the D input of flip-flop **134** is unasserted and when output pulse **122** is not asserted the D input of flip-flop **134** is asserted. The output of NAND gate **136** is connected to low asserting reset **138** of flip-flop **132**. The output of flip-flop **132** is integration pulse **140**. Integration pulse **140** and the output of inverter **128** are inputs to NAND gate **136**. Light-to-pulse circuit **142** accepts integration pulse **140** and the output of exposed light transducer **106** and produces output pulse **122**. Embodiments for light-to-pulse circuit **142** are described with regard to FIGS. **13–17** and **23–27** below.

In a preferred embodiment, light sensor **48,52** includes shielded light transducer **144** which does not receive light **104**. Light-to-pulse circuit **142** uses the output of shielded light transducer **144** to reduce the effects of noise in exposed light transducer **106**.

Referring now to FIG. 5, a timing diagram illustrating operation of the circuitry of FIG. 4 is shown. Initially, low asserting interconnect signal 114 is high. The state of flip-flop 132 must be zero for, if the state is one, both inputs to NAND gate 136 would be high, asserting reset 138 and forcing the state of flip-flop 132 to zero.

At time 150, dimming logic 56 asserts control line 118 turning transistor Q1 on. Interconnect signal 114 is then pulled low at time 152. The output of inverter 130 transitions from low to high setting the state of flip-flop 132 to one which causes integration pulse 140 to become asserted at time 154. Light-to-pulse circuit 142 begins integrating light 104 incident on exposed light transducer 106. At time 156, control line 118 is brought low turning transistor Q1 off. The difference between time 156 and time 150 is integration period 158 requested by dimming logic 56. Since both Q1 and Q2 are off, interconnect signal 114 is pulled high by current source 124 at time 160. Since the output of inverter 128 and integration pulse 140 are both high, reset 138 is asserted causing the state of flipflop 132 to change to zero and integration pulse 140 to become unasserted at time 162. This signals light-to-pulse circuit 142 to stop integrating light 104 incident on exposed light transducer 106.

At time 164, light-to-pulse circuit 142 asserts output pulse 122 to begin outputting light intensity information. Asserting output pulse 122 turns transistor Q2 on, pulling interconnect signal 144 low at time 166. This causes inverter 130 to output a low-to-high transition clocking a zero as the state of flip-flop 132. Light-to-pulse circuit 142 deasserts output pulse 122 at time 168. The difference between time 168 and time 164 is light intensity period 170 indicating the amount of light 104 incident on exposed light transducer 106 over integration period 158. Transistor Q2 is turned off when output pulse 122 goes low at time 168. Since both transistors Q1 and Q2 are off, interconnect signal 114 is pulled high at time 172. Buffer 120 in dimming logic 56 detects the transitions in interconnect signal 114 at times 166 and 172. The difference in time between times 172 and 166 is used by dimming logic 56 to determine the intensity of light 104 received by light sensor 48,52.

If shielded light transducer 144 is included in light sensor 48,52, the difference in time between the deassertion of integration pulse 140 at time 162 and the assertion of output pulse 122 at time 164 is due, in part, to the thermal noise in light sensor 48,52. This difference is expressed as thermal noise period 174. Thermal noise period 174 may be used by dimming logic 56 to determine the temperature of light sensor 48,52 or may be more simply used to determine if the noise level in sensor 48,52 is too high for a reliable reading. Dimming logic 56 may disable automatic dimming of dimming element 40 if the temperature of light sensor 48,52 exceeds a preset limit. The ability of light sensor 48,52 to use the output from shielded light transducer 144 to generate output pulse 122 indicative of the amount of thermal noise in light sensor 48,52 is described with regard to FIGS. 15-17 below.

Referring now to FIG. 6, a block diagram of a rearview mirror system with interior and exterior rearview mirrors according to embodiments of the present invention is shown. Dimming element 40 in interior rearview mirror 24 operates as described with regard to FIG. 2 above. Each exterior rearview mirror 26 includes exterior dimming element 180 having exterior variable transmittance element 182 operative to attenuate light from rearward scene 28 both prior to and after reflecting from exterior reflective surface 184. Exterior dimming element 180 provides variable reflectance based on exterior dimming element control signal 186.

Exterior dimming element 180 may operate in any manner described with regard to dimming element 40 and, preferably, is an electrochromic mirror. Exterior mirror control 188 generates exterior dimming element control signal 186. Exterior mirror control 188 may be part of exterior rearview mirror 26, interior rearview mirror 24, or may be located outside of any mirror 24,26. Various embodiments for controlling exterior dimming element 180 depend on the amount of sensing and control to be included within exterior rearview mirror 26.

In one embodiment, dimming logic 56 in interior rearview mirror 24 determines exterior dimming element control signal 186 based on output from ambient light sensor 48 and glare sensor 52. Exterior dimming element control signal 186 may be generated directly by dimming logic 56 or exterior mirror control 188 may generate exterior dimming element control signal 186 based on a reflectance level calculated in dimming logic 56 and transmitted to exterior mirror control 188 through inter-mirror signal 190.

In another embodiment, exterior rearview mirror 26 includes exterior glare sensor 192 positioned to receive glare 34 from rearward scene 28 and operative to output exterior glare signal 194 based on the amount of glare 34 incident on glare sensor 192 over a glare integration period. Since light sensors 48,52 with silicon-based charge accumulating transducers 106,144 have a lower cross-sensitivity to temperature, mounting light sensors 48,52 outside the body of vehicle 20 is more practical than with other types of light transducers. Dimming logic 56 uses exterior glare signal 194 and ambient light signal 50 to determine the reflectance level for exterior dimming element 180. Again, exterior dimming element control signal 186 may be generated directly by dimming logic 56 or may be developed by exterior mirror control 188 based on the reflectance level contained in inter-mirror signal 190. Exterior glare filter 196, similar to glare filter 60, may be placed before exterior glare sensor 192 or built into exterior glare sensor 192 to provide exterior glare sensor 192 with a response closer to the response of the human eye. Inter-mirror signal 190 and exterior glare signal 194 may be in the form of a pulse width modulated signal, pulse density signal, serial data stream, or digitized and communicated over an automotive bus such as the CAN bus.

In still another embodiment, exterior glare sensor 192 produces exterior glare signal 198 which is routed directly to exterior mirror control 188. Exterior mirror control 188 determines exterior dimming element control signal 186 based on exterior glare signal 198 and the level of ambient light 32 determined by dimming logic 56 and sent to exterior mirror control 188 through inter-mirror signal 190.

In yet another embodiment, exterior rearview mirror 26 determines reflectance for exterior dimming element 180 independent of glare 34 or ambient light 32 sensed by interior rearview mirror 24. In this embodiment, exterior rearview mirror 26 operates as described with regard to FIG. 2 above.

Referring now to FIG. 7, a schematic diagram illustrating an embodiment of the dimming logic is shown. The circuit represents an effective yet inexpensive implementation for automatically dimming interior rearview mirror 24. Dimming logic 56 utilizes a small, low cost microcontroller, indicated by U1, such as the PIC16C620 from Microchip Technology, Inc. of Chandler, Ariz. Ambient light sensor 48 communicates with microcontroller U1 through interconnection signal 114 connected to microcontroller input RBO. Similarly, glare sensor 52 communicates with microcontroller U1 through separate interconnection signal 114a con-

ected to microcontroller input RB2. As described with regard to FIGS. 4 and 5 above, each interconnection signal 114 carries integration period 158 from microcontroller U1 to light sensor 48,52 as well as light intensity period 170 from light sensor 48,52 to microcontroller U1. Resistor R29 and capacitor C4 connected between V_{DD} and ground provide filtered power for light sensors 48,52.

Parallel resistor R15 and diode D5 are connected between V_{DD} and node 208. Capacitor C12 is connected between node 208 and ground. Resistor R6 connects common node 208 to input IMCLR of microcontroller U1. Components D5, R15, R6, and C12 form a power-on reset circuit shown generally by 210. Power is supplied to dimming logic 56 through ignition line 212. Diode D1 protects from reversed polarity on ignition line 212 and diode D2 clamps the voltage derived from ignition line 212 to approximately five volts. Capacitors C2, C7 and C11, resistor R3, and ferrite element E1 form a power conditioning circuit shown generally by 214. Reverse line 216 is asserted when vehicle 20 is placed into reverse. Capacitor C10 and resistors R8, R9, and R27 form a reverse signal conditioning circuit, shown generally by 218. Reverse signal conditioning circuit 218 low pass filters reverse line 216 and provides electrostatic discharge protection for digital input pin RB6 on microcontroller U1. Microcontroller U1 uses the signal on reverse line 216 to clear variable transmittance element 42 whenever vehicle 20 is placed in reverse. Microcontroller U1 is clocked by an RC oscillator formed by resistor R2 connected between the OSC1 pin and V_{DD} and capacitor C1 connected between the OSC1 pin and ground. Resistor R30 and LED D3 connected in series between V_{DD} and open drain output RA4 of microcontroller U1 form an indicator lamp that may be mounted on interior rearview mirror 24 to alert operator 22 of the operating state of dimming logic 56. Switches S1 and S2 are connected to digital inputs RB1 and RB3, respectively, of microcontroller U1 to permit selecting control options.

Referring now to FIG. 8, a schematic diagram illustrating operation of electrochromic dimmer control is shown. A portion of dimmer logic 56 has been redrawn to more clearly illustrate control of electrochromic variable transmittance element 42. Electrochromic variable transmittance element 42 is preferably similar in operation to those described in U.S. Pat. No. 4,902,108 titled "Single-Compartment Self-Erasing, Solution-Phase Electrochromic Devices, Solutions For Use Therein, And Uses Thereof" to Byker, which is incorporated herein by reference. Electrochromic variable transmittance element 42 darkens in response to a control voltage applied at input node 220. If the applied control voltage is removed, electrochromic variable transmittance element 42 will self discharge, transmitting an increasing amount of light. Electrochromic variable transmittance element 42 may be rapidly cleared by shorting input node 220 to ground. While the application described pertains particularly to automotive rearview mirrors, it will be understood by one of ordinary skill in the art that all or part of dimmer logic 56 may be used in a wide variety of electrochromic mirror and window applications.

Resistor R17 connects input node 220 to the emitter of Darlington pair Q10 at node 222. The collector of Q10 is connected to a power supply through current limiting resistor R5, typically 27 Ω . The base of Darlington pair Q10 is connected to digital output RB4 of microcontroller U1 through resistors R1 and R7. The base of Q10 is also connected to ground through resistor R4 and through resistor R7 and capacitor C16. Digital output pin RB4 is driven by pulse output 224 in response to pulse control 226 generated

by software running on microcontroller U1. Pulse output 224 may produce a pulse signal such as, for example, a pulse width modulated signal. Preferably, pulse output 224 functions as a switch, setting output pin RB4 to either a high voltage or a low voltage once during each transition period as described with regards to FIG. 9 below. Capacitor C16 and resistors R1, R4, and R7 form a low pass filter, shown generally by 227, to smooth the signal appearing on digital output RB4. This smoothing results in a substantially constant applied control voltage at input node 220 for a fixed desired control level. Additionally, the base-to-emitter diode drops in Q10 together with the voltage divider formed between resistor R4 and the sum of resistors R1 and R7 set the operating voltage for electrochromic variable transmittance element 42. Typical values for components are 1 k Ω for R1 and R4, 100 Ω for R7, and 100 μ F for C16. With digital output RB4 at 5 volts and nominal current draw by electrochromic variable transmittance element 42, input node 220 is approximately 1.2 volts.

The performance of dimming logic 56 can be improved through feedback of electrochromic variable transmittance element 42 applied control voltage at input node 220. Microcontroller U1 includes comparison logic to cause pulse output 224 to deliver a low voltage if the applied control voltage is greater than the desired control level and to deliver a high voltage otherwise. Typically, the high voltage is near V_{DD} and the low voltage is near ground. This comparison may be made by comparing a digital number representing the desired control level with the digitized applied control voltage obtained using an analog-to-digital converter. Alternately, digital-to-analog converter (DAC) 228 and comparator 230 are used. DAC 228 produces a desired voltage level on analog output AN2 in response to the desired control level on DAC control 232 supplied by software running on microcontroller U1. Resistor R31 is connected between analog output AN2 and node 234 and resistor R26 is connected between node 234 and ground. One input of comparator 230, at analog input AN3, is connected to node 234. The other input of comparator 230, at analog input AN0, is connected to input node 220. The output of comparator 230 indicates if the desired voltage level is greater than the applied control voltage. Values for resistors R31 and R26 are chosen so that the voltage at node 234 is within the range of expected applied control voltages at input node 220 throughout the range of desired control voltages output from DAC 228. Typical values for R31 and R26 are 390 k Ω and 200 k Ω , respectively.

Positive feedback is achieved by connecting resistor R24 between node 234 and node 222. Resistor R17 is used to sense the drive current through electrochromic variable transmittance element 42 and, hence, is typically a low value such as 10 Ω . Resistor R24 is typically a high value such as 1.3 M Ω . As the drive current through resistor R17 increases, the voltage across resistor R17 increases pulling up the voltage at node 234. This increase in the voltage on the positive input terminal of comparator 230 has the regenerative effect of increasing the duty cycle from pulse output 224. This regenerative effect provides better system response at higher temperatures when electrochromic variable transmittance element 42 has an increased current draw together with an increase in maximum operating voltage. Positive feedback also offsets the effects of internal resistances within electrochromic variable transmittance element 42.

Referring now to FIG. 9, a timing diagram illustrating electrochromic element transmittance control is shown. During automatic dimming operation, software executing in

microcontroller U1 is initiated at transition points, one of which is indicated by 240, separated by fixed transition period 242. Desired control level 244 indicates the desired level of transmittance for electrochromic variable transmittance element 42. Desired control level 244 may be an analog value or, preferably, is a digital number determined by microcontroller U1. Desired control level 244 is compared to applied control voltage 246 by comparison logic. Comparator 230 accepts applied control voltage 246 and the desired control voltage appearing at node 234. Comparator output 236 produces difference signal 248 which is asserted when the desired voltage level representing desired control level 244 is greater than applied control voltage 246. Comparator output 236 is used to generate control signal 250 on output RB4. If desired control level 244 is greater than applied control voltage 246, digital output RB4 is switched high. If desired control level 244 is less than applied control voltage 246, digital output RB4 is switched low. Preferably, low pass filter 227 filters control signal 250 to produce applied control voltage 246.

The duration of transition period 242 is set to inhibit flicker in electrochromic element 42 that may be noticed, for example, by vehicle operator 22. Transition period 242 may preferably be between two seconds and two microseconds. For the system described with regards to FIGS. 7 and 8 above, five milliseconds may be used for transition period 242.

Referring now to FIG. 10, a graph indicating dimmer reflectance as a function of applied control voltage is shown. Curve 254 plots reflection as a percentage for dimming element 40 containing electrochromic variable transmittance element 42 as a function of applied control voltage 256. Curve 254 indicates a decrease in reflection from about 86% to about 8% as the applied control voltage is increased from about 0.2 V to about 0.9 V. FIG. 10 also includes curve 256 illustrating current draw as a function of applied control voltage 256 for typical electrochromic variable transmittance element 42.

Referring again to FIG. 7, additional circuitry is provided to rapidly clear variably transmissive electrochromic element 40. Transistor Q11 is connected across variably transmissive electrochromic element 40 with collector at node 220 and emitter at ground. The base of transistor Q11 is connected through resistor R23 to digital output RB7. When digital output RB7 is asserted, transistor Q11 turns on, acting as a switch to rapidly discharge electrochromic variable transmittance element 42. Capacitor C6 is connected between the collector and base of transistor Q11 to reduce electromagnetic interference created as transistor Q11 switches. Transistor Q12 is connected between the base of transistor Q10 and ground and is also controlled by digital output RB7. Transistor Q11 turns on with transistor Q12 to shut off transistor Q10 thereby preventing simultaneously attempting to darken and clear electrochromic variable transmittance element 42. Resistor R7 is placed between capacitor C16 and the collector of transistor Q12 to limit the discharge current from capacitor C16 through transistor Q12.

Referring now to FIG. 11, a flow diagram illustrating operation of dimming logic according to an embodiment of the present invention is shown. As will be appreciated by one of ordinary skill in the art, the operations illustrated are not necessarily sequential operations. Also, though the operations are preferably implemented by software executing in microcontroller U1, operations may be performed by software, hardware, or a combination of both. The present invention transcends any particular implementation and aspects are shown in sequential flow chart form for ease of illustration.

An ambient light reading is taken and the average ambient light is initialized in block 260. When the automatic dimming system is initially powered up, the average ambient light level is initialized by taking a first reading of ambient light 32 using ambient light sensor 48. Acquiring an ambient light reading and the average ambient light level are described with regard to blocks 262 and 270, respectively, below.

An ambient light reading is taken and the log of the ambient light reading is found in block 262. The use of semiconductor ambient light sensor 48 with integral charge collection produces ambient light signal 50 having good resolution over a wide range of ambient light levels 32. As described with regard to FIG. 3 above, this is accomplished by taking various readings of ambient light 32 using different integration periods 76,82,88. In a preferred embodiment, four separate integration periods are used such as, for example, 600 μ s, 2.4 ms, 9.6 ms, and 38.4 ms. Each of these integration periods differs by a factor of four from adjacent periods. Therefore, for example, the 2.4 ms integration period causes ambient light sensor 48 to act four times more sensitive to ambient light 32 than does integrating with the 600 μ s integration period. Typically, the shortest integration pulse 74 is first used by ambient light sensor 48 to produce short signal pulse 78. The width of short signal pulse 78 is measured by dimming logic 56. Since ambient light sensor 48 in complete darkness may still develop short signal pulse 78 having a width less than 100 μ s, a minimum threshold is set for accepting short signal pulse 78 as accurately reflecting the level of ambient light 32. Typically, this threshold may be 300 μ s. If short signal pulse 78 does not exceed the threshold, the next longest integration period is used by ambient light sensor 48. If the longest integration time does not yield a suitably long signal pulse, ambient light 32 is at an extremely low level and mirror 24,26 can be operated at maximum sensitivity to glare 34.

Using the logarithm of ambient light signal 50 permits the use of an inexpensive microcontroller such as U1 which may have only 8-bit internal registers and no multiplication instructions. Since microcontrollers are binary devices, base two logarithms require fewer instructions to compute than base ten logarithms or natural logarithms. An algorithm is now described for obtaining an 8-bit, binary logarithm having the most significant four bits representing an integer part and the least significant four bits a fractional part. The 8-bit ambient light signal 50 resulting from the proper integration period is examined bit-by-bit starting with the most significant bit until the first binary one is found. The bit position containing the first binary one becomes the integer portion of the logarithm. The four most significant bits following the bit position containing the first binary one become the fractional portion of the logarithm. This value is incremented by one-sixteenth to better approximate the logarithm. An example of the binary logarithm approximation is now provided. Suppose ambient light signal 50 is determined to be 44 (00101101 in base two). The most significant asserted bit is bit five, so the integer portion of the resultant value is binary 0101. The next four bits following bit five are 0110 so the fractional part of the resultant value is 0110 for a total value of 0101.0110. After incrementing, the binary logarithm approximation becomes 0101.0111.

Referring now to FIG. 12, a graph illustrating binary log approximation according to the above algorithm is shown. The binary logarithm is plotted for values of N between 1 and 255. Curve 290 shows the actual binary logarithm. Curve 292 shows the approximated binary logarithm.

Ambient light signal 50 must be scaled to compensate for different possible integration periods. This may be accom-

plished by adding a scaling factor to the binary logarithm of ambient light signal **50**. For example, if the longest integration time (38.4 ms) is used to measure ambient light **32**, a scale factor of 0 is added. If the next longest integration time (9.6 ms) is used, a scale of factor of 2 is added. If the next longest integration time (2.4 ms) is used, 4 is added. If the by shortest integration time (600 μ s) is used, 6 is added. Since the largest value resulting from the binary logarithm approximation is 8 (1000.0000), no overflow results from adding the scale factor.

Referring again to FIG. **11**, the logarithm of the ambient light level is compared to the day detect level in block **264**. The day detect level is used to prevent dimming of or to more rapidly clear dimming element **40** during rapid transitions from dark to bright such as if vehicle **20** emerges from a tunnel into daylight. If the logarithm of ambient light **32** exceeds a preset day detect level, variable transmittance element **42** is cleared to set dimming element **40** to maximum reflectance in block **266**. Processing is then delayed in block **268**. A wait loop is entered having a time sufficiently long to make the period between taking ambient light readings equal a constant ambient light loop delay. This period may be, for example, 400 ms. Following the wait in block **268**, another reading of ambient light **32** is taken in block **262**. If the logarithm of ambient light **32** does not exceed the day detect level, an average is obtained in block **270**.

The average of the logarithm of ambient light level is determined in block **270**. Averaging readings first converted to the logarithm of ambient light **32** reduces the effect of a temporary bright light in front of vehicle **20** from dramatically skewing the average reading of an otherwise dark ambient light **32**. A running average of the log of ambient light signals **50** may be obtained from a digital low pass filter such as is described by Equation 1:

$$y(n) = \frac{1}{64} x(n) + \frac{63}{64} y(n-1) \quad (1)$$

where $x(n)$ is the most recently obtained binary log approximation of ambient light signal **50** correctly scaled for the integration period, $y(n-1)$ is the previous filter output, and $y(n)$ is the current filter output. The use of averaged logarithms with analog light signals is described in U.S. Pat. No. 5,204,778 titled "Control System For Automotive Rearview Mirrors" to Bechtel, which is incorporated herein by reference.

The average of the log of the ambient light level is compared to a threshold in block **272**. If ambient light **32** is sufficiently bright, vehicle operator **22** will not be dazzled by any reasonable amount of glare **34** allowing mirror **24,26** to be set to maximum reflectance. Therefore, if the average of the log of ambient light signal **50** is not less than the threshold, dimming element **40** is cleared in block **266** and the wait of block **268** is executed. If the average of the log of ambient light signals **50** is less than the threshold, glare processing occurs beginning in block **274**. Typically, the threshold used for comparison in block **272** is less than the day detect level used in the comparison of block **264**.

The glare integration period is determined in block **274**. The integration period for glare sensor **52** is determined based on ambient light signal **50**. The glare integration period is inversely proportional to the binary antilogarithm of the average of the log of ambient light signal **50** as described by Equation 2:

$$T_G(n) = \text{antilog}_2((K_1 - y(n)) - K_2) \quad (2)$$

where $T_G(n)$ is the integration period for glare sensor **52** for the filter output at sample time n , K_1 is a multiplicative constant, and K_2 is an additive constant. Constants K_1 and K_2 are determined experimentally. If the average of the log of ambient light signal **50** is below a certain level, a maximum glare sensitivity integration period is used.

A glare count is set in block **276**. The glare count indicates the number of glare readings taken between ambient light readings. The product of the glare count and the glare loop delay should equal the time between taking ambient light readings. For example, the glare count may be three and the time between taking glare readings may be 133 ms.

A glare reading is taken in block **278**. The pulse width returning from glare sensor **52** as glare signal **54** is measured for the glare integration period determined in block **274**.

The dimming element value is set in block **280**. Glare signal **54** is used to determine desired control level **244** setting the reflectance for dimming element **40**. This may be accomplished, for example, through the use of a look-up table. The precise relationship between the level of glare **34** and the setting for variable transmittance element **42** depends upon factors including the construction of mirror **24,26**, the configuration of vehicle **20**, and preferential settings by operator **22**. Desired control level **244** may be used to control variable transmittance element **42** as described with regards to FIGS. **7-10** above.

A check of the glare count is made in block **282**. If the glare count is zero, the next ambient light reading is taken in block **262**. If the glare count is not zero, the glare count is decremented in block **284**. A wait loop is then entered in block **286**. The glare loop delay period is set so that glare readings are taken at regular, predetermined intervals.

Referring now to FIG. **13**, a schematic diagram illustrating operation of a light sensor having a pulse output according to an embodiment of the present invention is shown. Light-to-pulse circuit **300** includes exposed light transducer **106** for converting light **104** incident on exposed light transducer **106** into charge accumulated in light storage capacitor **304**, indicated by C_{SL} . Exposed light transducer **106** may be any device capable of converting light **104** into charge, such as the photogate sensor described in U.S. Pat. No. 5,471,515 titled "Active Pixel Sensor With Intra-Pixel Charge Transfer" to E. Fossum et al., which is incorporated herein by reference. Preferably, light transducer **106** is a photodiode such as is described with regards to FIGS. **25** and **26** below. Except as noted, the following discussion does not depend on a particular type or construction for exposed light transducer **106**.

Light-to-pulse circuit **300** operates under the control of sensor logic **306**. Sensor logic **306** generates reset signal **308** controlling switch **310** connected between exposed light transducer output **312** and V_{DD} . Sensor logic **306** also produces sample signal **314** controlling switch **316** between exposed light transducer output **312** and light storage capacitor **304**. The voltage across light storage capacitor **304**, light storage capacitor voltage **318**, is fed into one input of comparator **320**. The other input of comparator **320** is ramp voltage **322** across ramp capacitor **324**. Ramp capacitor **324** is in parallel with current source **326** generating current I_R . Sensor logic **306** further produces ramp control signal **328** controlling switch **330** connected between ramp voltage **322** and V_{DD} . Comparator **320** produces comparator output **332** based on the relative levels of light storage capacitor voltage **318** and ramp voltage **322**. Sensor logic **306** may generate reset signal **308**, sample signal **314**, and ramp control signal **330** based on internally generated timing or on externally generated integration pulse **140** as described with regard to FIGS. **18-21** below.

Referring now to FIG. 14, a timing diagram illustrating operation of the light sensor of FIG. 13 is shown. A measurement cycle is started at time 340 when sample signal 314 is asserted while reset signal 308 is asserted. This closes switch 316 to charge light storage capacitor 304 to V_{DD} as indicated by voltage level 342 in light storage capacitor voltage 318. Reset signal 308 is then deasserted at time 344, opening switch 310 and beginning integration period 346. During integration period 346, light 104 incident on exposed light transducer 106 generates negative charge causing declining voltage 348 in light storage capacitor voltage 318. At time 350, ramp control signal 328 is asserted closing switch 330 and charging ramp capacitor 324 so that ramp voltage 322 is V_{DD} as indicated by voltage level 352.

Sample signal 314 is deasserted at time 354, causing switch 316 to open, thereby ending integration period 346. At some time 356 following time 354 and prior to the next measurement cycle, reset signal 308 must be asserted closing switch 310. At time 358, ramp control signal 328 is deasserted opening switch 330. This causes ramp capacitor 324 to discharge at a constant rate through current source 326 as indicated by declining voltage 360 in ramp voltage 322. Initially, as indicated by voltage level 362, comparator output 332 is unasserted because ramp voltage 322 is greater than light storage capacitor voltage 318. At time 364, declining voltage 360 in ramp voltage 322 drops below light storage capacitor voltage 318 causing comparator output 332 to become asserted. Comparator output 322 remains asserted until time 366 when ramp control signal 328 is asserted closing switch 330 and pulling ramp voltage 322 to V_{DD} . The difference between time 366 and time 364, indicated by pulse duration 368, is inversely related to the amount of light 104 received by exposed light transducer 106 during integration period 346.

Referring now to FIG. 15, a schematic diagram illustrating operation of a light sensor with noise compensation according to an embodiment of the present invention is shown. A light-to-pulse circuit, shown generally by 380, improves upon light-to-pulse circuit 300 by incorporating shielded light transducer 144 and associated electronics. Shielded light transducer 144 preferably has the same construction as exposed light transducer 106. However, shielded light transducer 144 does not receive light 104. Charge generated by shielded light transducer 144, therefore, is only a function of noise. This noise is predominately thermal in nature. If shielded light transducer 144 has the same construction as exposed light transducer 106, the noise signal produced by shielded light transducer 144 will closely approximate the same noise within the signal produced by exposed light transducer 106. By subtracting the signal produced by shielded light transducer 144 from the signal produced by exposed light transducer 106, the effect of noise in light transducer 106 can be greatly reduced.

Reset signal 308 controls switch 382 connected between shielded transducer output 384 and V_{DD} . Sample signal 314 controls switch 386 connected between shielded transducer output 384 and noise storage capacitor 388, indicated by C_{SN} . The voltage across noise storage capacitor 388, noise storage capacitor voltage 390, is one input to comparator 392. The second input to comparator 392 is ramp voltage 322. The output of comparator 392, noise comparator output 394, and comparator output 332 serve as inputs to exclusive-OR gate 396. Exclusive-OR gate 396 generates exclusive-OR output 398 indicating the intensity of light 104.

Referring now to FIG. 16, a timing diagram illustrating operation of the light sensor of FIG. 15 is shown. Light-to-pulse circuit 380 functions in the same manner as light-to-

pulse circuit 300 with regard to reset signal 308, sample signal 314, light storage capacitor voltage 318, ramp voltage 322, ramp control signal 328, and comparator output 332. At time 340, sample signal 314 is asserted while reset signal 308 is asserted. Switches 382 and 386 are both closed charging noise storage capacitor 388 to V_{DD} as indicated by voltage level 410 in noise storage capacitor voltage 390. At time 344, reset signal 308 is deasserted opening switch 382 and causing declining voltage 412 in noise storage capacitor voltage 390 from charge produced by shielded light transducer 144 due to noise. At time 354, sample signal 314 is deasserted ending integration period 346 for noise collection. At time 358, ramp control signal 328 is deasserted causing declining voltage 360 in ramp voltage 322. Initially, as indicated by voltage level 414, noise comparator output 394 is unasserted because ramp voltage 322 is greater than noise storage capacitor voltage 390. Since comparator output 332 is also unasserted, output 398 from comparator 396 is unasserted as indicated by voltage level 416. At time 418, ramp voltage 322 drops below the level of noise storage capacitor voltage 390, causing noise comparator output 394 to become asserted. Since noise comparator output 394 and comparator output 332 are different, output 398 from comparator 396 is asserted. At time 364, ramp voltage 322 drops beneath the level of light storage capacitor voltage 318, causing comparator output 332 to become asserted. Since both noise comparator output 394 and comparator output 332 are now asserted, output 398 from exclusive-OR gate 396 now becomes unasserted. The difference between time 364 and time 418, output pulse duration 420, has a time period proportional to the intensity of light 104 incident on exposed light transducer 106 less noise produced by shielded light transducer 144 over integration period 346. The duration between time 418 and time 358, noise duration 422, is directly proportional to the amount of noise developed by shielded light transducer 144 over integration period 346. Since the majority of this noise is thermal noise, noise duration 422 is indicative of shielded light transducer 144 temperature. At time 366, ramp control signal 328 is asserted, deasserting both noise comparator output 394 and comparator output 332.

Referring now to FIG. 17, a schematic diagram of an implementation of the light sensor of FIG. 15 using photodiodes as light transducers is shown. Light-to-pulse circuit 380 is implemented using exposed photodiode 430 for exposed light transducer 106 and shielded photodiode 432 for shielded light transducer 144. The anode of exposed photodiode 430 is connected to ground and the cathode connected through transistor Q20 to V_{DD} . The base of transistor Q20 is controlled by reset signal 308. Hence, transistor Q20 functions as switch 310. Transistors Q21 and Q22 are connected in series between V_{DD} and ground to form a buffer, shown generally by 434. The base of transistor Q21 is connected to the collector of exposed photodiode 430. The base of load transistor Q22 is connected to fixed voltage V_B . The output of buffer 434 is connected through transistor Q23 to light storage capacitor 304. The base of transistor Q23 is driven by sample signal 314, permitting transistor Q23 to function as switch 316. The anode of shielded photodiode 432 is connected to ground and the cathode is connected to V_{DD} through transistor Q24. The base of transistor Q24 is driven by reset signal 308 permitting transistor Q24 to function as switch 382. Transistors Q25 and Q26 form a buffer, shown generally by 436, isolating the output from shielded photodiode 432 in the same manner that buffer 434 isolates exposed photodiode 430. Transistor Q27 connects the output of buffer 436 to

noise storage capacitor **388**. The base of transistor **Q27** is driven by sample signal **314** permitting transistor **Q27** to function as switch **386**. Typically, light storage capacitor **304** and noise storage capacitor **388** are 2 pF. Ramp capacitor **324**, typically 10 pF, is charged to V_{DD} through transistor **Q28**. The base of transistor **Q28** is driven by ramp control signal **328** permitting transistor **Q28** to function as switch **330**. Ramp capacitor **324** is discharged through current source **326** at an approximately constant current I_R of 0.1 μA when transistor **Q28** is off.

Sensor power-up response is improved and the effective dynamic range extended by including circuitry to inhibit output if ramp voltage **322** drops beneath a preset voltage. Light-to-pulse circuit **380** includes comparator **438** comparing ramp voltage **322** with initialization voltage (V_{INIT}) **440**. Comparator output **442** is ANDed with exclusive-OR output **396** by AND gate **444** to produce AND gate output **446**. During operation, if ramp voltage **322** is less than initialization voltage **440**, output **446** is deasserted. The use of comparator **438** and AND gate **444** guarantee that output **446** is not asserted regardless of the state of light-to-pulse circuit **380** following power-up. In a preferred embodiment, the initialization voltage is 0.45 V.

Sensor logic **306** generates control signals **308**, **314**, **328** based on integration pulse **140** which may be generated internally or provided from an external source. Buffer **447** receives integration pulse **140** and produces sample control **314**. An odd number of sequentially connected inverters, shown generally as inverter train **448**, accepts sample control **314** and produces reset control **308**. A second set of odd numbered sequentially connected inverters, shown generally as inverter train **449**, accepts reset signal **308** and produces ramp control signal **328**. The circuit shown in FIG. 17 has a resolution of at least 8 bits and a sensitivity of approximately 1 volt per lux-second. The maximum output pulse duration **420** is independent of integration period **346** provided by the duration of integration pulse **140**.

Referring now to FIGS. 18–21, various embodiments for light sensor packaging, output, and control are shown. Each embodiment may include light-to-pulse pulse circuitry as described with regard to FIGS. 13–17 above. In FIG. 18, light sensor package **450** accepts four pins for supply voltage V_{DD} , ground, integration period signal **452**, and output signal **454**. Integration period signal **452** may be integration pulse **140** used by light-to-pulse circuit **380** to produce output **398** which is sent as output signal **454**. In FIG. 19, light sensor package **456** requires only three pins for V_{DD} , ground, and combined integration period and output signal **458**. Combined signal **458** may be interconnect signal **114** as described with regard to FIGS. 4 and 5 above. In FIG. 20, light sensor package **460** admits three pins for output signal **454**, ground, and combined V_{DD} and integration period signal **462**. As is known in the art, combined signal **462** may be separated into power supply voltage V_{DD} and integration period signal **452** through the use of filters. In FIG. 21, light sensor package **464** admits three pins for V_{DD} , ground, and output signal **454**. Integration period signal **452** is generated within light sensor package **464** as described with regard to FIG. 22 below.

Referring now to FIG. 22, a block diagram of sensor logic for internally determining the integration period signal is shown. Sensor logic **306** may include free-running counter **470** driven by internal oscillator **472**. Counter **470** may have taps, one of which is indicated by **474**, connected to different counter bits. For example, one tap **474** may be connected to the n^{th} bit, the next tap **474** to the $n^{\text{th}}+2$ bit, the next tap **474** connected to the $n^{\text{th}}+4$ bit, and so on, with each successive

tap thereby providing a pulse with a period four times longer than the preceding tap **474**. Sensor control signal generator **476** controls switch **478** to determine which tap **474** will be used to produce integration pulse **140**. Typically, sensor control signal generator **476** sequences through each tap **474** repeatedly. Sensor control signal generator **476** then uses integration pulse **140** to generate control signals such as reset signal **308**, sample signal **314**, and ramp control signal **328** as described with regards to FIG. 17 above.

Referring now to FIG. 23, a block diagram illustrating the use of light transducers having different effective areas to achieve increased dynamic range is shown. As an alternative to or together with varying the integration time, pairs of exposed light transducer **106** and shielded light transducer **144** having different effective areas may be used. If photo-diodes **430,432** are used as light transducers **106,144**, the effective area is the photodiode collector area. Small exposed light transducer **490** produces charge which is converted to a voltage by light-to-voltage circuit **492**. Light-to-voltage circuit **492** may be implemented using switches **310**, **316**, and light storage capacitor **304** as described with regard to FIG. 15 above. Charge produced by small shielded light transducer **494** is converted to voltage by noise-to-voltage circuit **496**. Noise-to-voltage circuit **496** may be implemented using switches **382**, **386** and noise storage capacitor **388** as described with regard to FIG. 15 above. The outputs of light-to-voltage circuit **492** and noise-to-voltage circuit **496** are converted to a pulse with a width based on charge accumulated by small exposed light transducer **490** less charge due to noise integrated by small shielded light transducer **494** over an integration period by voltage-to-pulse circuit **498**. Voltage-to-pulse circuit **498** may be implemented using comparators **320**, **392**, capacitor **324**, current source **326**, and gate **396** as described with regard to FIG. 15 above. Medium exposed light transducer **500** has an effective area larger than the effective area for small exposed light transducer **490**, resulting in increased sensitivity. For example, if the effective area of medium exposed light transducer **500** is four times larger than the effective area of small exposed light transducer **490**, medium exposed light transducer **500** will be four times more sensitive to light **104** than will be small exposed light transducer **490**. Medium shielded light transducer **502** has an effective area the same as medium exposed light transducer **500**. Additional light-to-voltage circuit **492**, noise-to-voltage circuit **496**, and voltage-to-pulse circuit **498** produce a noise-corrected output pulse with width based on light **104** incident on medium exposed light transducer **500**. Similarly, large exposed light transducer **504** and large shielded light transducer **506** provide still increased sensitivity over medium exposed light transducer **500** and medium shielded light transducer **502** by having still greater effective area.

Switch **508** under the control of sensor logic **306** sets which output from voltage-to-pulse circuits **498** will be used for output signal **454**. Output signal **454** may be selected based on a signal generated within sensor logic **306** or may be based on a signal provided from outside of sensor logic **306**.

In an alternative embodiment, only one shielded light transducer **144** is used. The output of shielded light transducer **144** is scaled prior to each noise-to-voltage circuit **496** in proportion to the varying effective areas of exposed light transducers **106**. It will be recognized by one of ordinary skill in the art that, though the examples shown in FIG. 23 has three pairs of exposed light transducer **106** and shielded light transducer **144**, any number of pairs may be used.

Referring now to FIG. 24, a block diagram illustrating the use of light transducers having different apertures to achieve

increased dynamic range is shown. As an alternative to or together with specifying the integration period, exposed light transducers 106 having the same effective area may each have a different aperture admitting area for admitting light 104. Varying apertures may be produced using partial shield 520 blocking light 104 from reaching a portion of exposed light transducer 106. Each exposed light transducer 106 produces charge converted to a voltage by a corresponding light-to-voltage circuit 492. Switch 522 under the control of sensor logic 306 selects which output of light-to-voltage circuits 492 to forward to voltage-to-pulse circuit 498. Voltage-to-pulse circuit 498 produces output signal 454 compensated for noise sensed by shielded light transducer 144 and processed by noise-to-voltage circuit 496. Sensor logic 306 may select output of light-to-voltage circuits 492 based on an internally generated control signal or on a control signal received from outside of sensor logic 306.

Referring now to FIG. 25, a schematic diagram illustrating different transducer capacitances for different amounts of light-induced charge to achieve increased dynamic range is shown. A photodiode, shown generally by 530, is formed by n-type diffusion 532 in p-type substrate 534. Light 104 incident on photodiode 530 generates charge 536 which may be accumulated in photodiode well 538 beneath n-type diffusion 532. Photodiode 530 has intrinsic photodiode capacitance C_{PD} . Floating diffusion 540 is also formed by diffusing n-type material in substrate 534. Floating diffusion 540 is connected through transistor Q20 to reset voltage V_{RESET} . The gate of transistor Q20 is connected to reset signal 308 under the control of sensor logic 306. Floating diffusion 540 is also connected to the input of buffer 542. The output of buffer 542 is transducer output V_{OUT} . Floating diffusion 540 defines diffusion well 544 formed in a region of substrate 534 when reset signal 308 is asserted. Floating diffusion 540 has an intrinsic floating diffusion capacitance C_{FD} . Transmission gate 546 is positioned between diffusion 532 and floating diffusion 540. Transmission gate 546 is held at voltage V_{TG} to form transmission well 548 thereunder. Transmission well 548 has a depth shallower than photodiode well 538 and diffusion well 544. Transmission gate 546 has an intrinsic transmission gate capacitance C_{TG} .

When reset signal 308 is asserted, bringing floating diffusion 540 to V_{RESET} , charge is eliminated in diffusion well 544. Further, when charge is reset in diffusion well 544, any charge 536 in photodiode well 538 above the depth of transmission well 548 flows through transmission well 548, through floating diffusion 540, and is eliminated. During a light integration period, reset signal 308 is unasserted, causing the voltage of floating diffusion 540 to float based on the amount of charge 536 in diffusion well 544. As light 104 strikes diffusion 532, charge 536 is created. Since charge 536 in photodiode well 538 up to the level of transmission well 548 was not eliminated by charge reset, additional charge 536 produced by incident light 104 flows from photodiode well 538 through transmission well 548 and into diffusion well 544. At charge level 550, beneath the level of transmission well 548, only diffusion well 544 is filling with charge 536. Hence, the voltage of floating diffusion 540 is inversely proportional to floating gate capacitance C_{FD} . When enough charge 536 has been generated to fill diffusion well 544 above the level of transmission well 548 such as, for example level 552, diffusion well 544, transmission well 548, and photodiode well 538 all fill with charge 536. Hence, the voltage of floating diffusion 540 is now inversely proportional to the sum of floating diffusion capacitance C_{FD} , transmission gate capacitance C_{TG} , and photodiode capacitance C_{PD} .

Referring now to FIG. 26, a graph of output potential as a function of accumulated incident light for the transducer of FIG. 25 is shown. A curve, shown generally by 554, shows transducer output V_{OUT} as a function of light 104 incident on diffusion 532 and, possibly, floating diffusion 540 over the integration period. During steep portion 556, charge 536 is accumulating in diffusion well 544 alone. Since the conversion gain is based only on floating diffusion capacitance C_{FD} , photodiode 530 appears to have a high sensitivity to incident light 104. During shallow portion 558, charge 536 is accumulated in diffusion well 544, transmission well 548, and photodiode well 538. Since the conversion gain is now dependent on the parallel combination of capacitances C_{FD} , C_{TG} , and C_{PD} , photodiode 530 now appears less sensitive to incident light 104. By adjusting voltages V_{RESET} and V_{TG} , knee point 559 between steep portion 556 and shallow portion 558 can be shifted affecting the dynamic range. For example, if the maximum voltage swing for floating diffusion 540 is 1 volt; the ratio of C_{FD} to the sum of C_{FD} , C_{TG} , and C_{PD} is 1:100; and knee point 559 is set at 0.5 volts, the dynamic range of photodiode 530 is increased about 50 times over the dynamic range of a similar photodiode without dual capacitance.

Referring now to FIG. 27, a schematic diagram illustrating a photodiode transducer incorporating an anti-bloom gate according to an embodiment of the present invention is shown. Anti-bloom gate 560 is formed between diffusion 532 and source voltage diffusion 562 tied to V_{DD} . Anti-bloom gate 560 is tied to anti-bloom voltage V_{AB} . Anti-bloom gate 560 forms anti-bloom well 564 in substrate 534 between photodiode well 538 and source diffusion well 566. Anti-bloom voltage V_{AB} is less than transmission gate voltage V_{TG} well 564, making anti-bloom well 564 shallower than transmission well 548. When accumulated charge generated by photodiode 530 exceeds charge level 568 equal to the depth of anti-bloom well 564, the excess charge flows beneath anti-bloom gate 560 into source voltage diffusion 562 and is eliminated. Anti-bloom gate 560 prevents output voltage V_{OUT} from dropping below a level detectable by comparator 320 in light-to-pulse circuit 380.

Referring now to FIG. 28, a drawing illustrating enclosure for a light sensor according to an embodiment of the present invention is shown. Light sensor 48,52 includes enclosure 100 having window 102 for admitting light, one ray of which is indicated by 570. Enclosure 100 admits power pin 108, ground pin 110, and signal pin 112. Semiconductor die 572, encapsulated within enclosure 100, incorporates light transducers 106,144 and associated electronics as described with regards to FIGS. 4-5 and 13-26 above. Pins 108,110, 112 may be wire bonded to die 527, as shown by wire 574 for power pin 108 and wire 576 for signal pin 112, or may be directly bonded to die 527, as shown for ground pin 110.

Preferably, enclosure 100 is the same type used to construct three-terminal light emitting diodes (LEDs). A preferred format is commonly referred to as the T-1 $\frac{3}{4}$ or 5 mm package. Encapsulating electronics in such packages is well known in the art of optical electronics manufacturing.

A lens, shown generally by 578, is preferably used to focus light onto exposed light transducer 106. Lens 578 may be placed in front of light sensor 48,52 or, preferably, may be incorporated into window 102 as shown in FIG. 28. Lens 578 defines the field of view of light sensor 48,52 and provides improved sensitivity through optical gain.

Referring now to FIG. 29, a graph illustrating light sensor field of view as a function of light transducer distance from the lens is shown. The field of view for exposed light transducer 106 in light sensor 48,52 is defined as view angle

θ made by marginal ray **570** with respect to optical axis **580** through exposed light transducer **106**. The half angle field of view for spherical lens **578** is expressed by Equation 3:

$$\theta = 90 - \arccos\left(\frac{r}{R}\right) + \frac{n_2}{n_1} \cdot \sin\left(\arccos\left(\frac{r}{R}\right) - \arctan\left(\frac{d - (R - \sqrt{R^2 - r^2})}{r}\right)\right) \quad (3)$$

where r is the lens aperture radius, R is the radius of curvature of lens **578**, n_2 is the index of refraction of material within enclosure **100**, n_1 is the index of refraction outside of enclosure **100**, d is the distance from the center of lens **578** to exposed light transducer **106**, and θ is measured in degrees. Typically, T-1 $\frac{3}{4}$ enclosure **100** is filled with epoxy and sensor **48,52** operates in air making the ratio of n_2 to n_1 approximately 1.5. Curve **590** plots half angle field of view θ as a function of distance d for a T-1 $\frac{3}{4}$ enclosure having a spherical lens **578** with radius R of 5.0 mm. As light transducer **106** moves farther from lens **578**, the field of view decreases.

Referring now to FIG. **30**, a graph illustrating light sensor optical gain as a function of light transducer distance from the lens is shown. Assuming paraxial approximation for rays **570**, the optical gain of lens **578** can be estimated by considering the ratio of additional optical energy collected by light transducer **106** with lens **578** to the optical energy collected by light transducer **106** without lens **578**. This can be computed by considering a cone of light with a base at the surface of lens **578** and a point at the focal point f of lens **578**. The optical gain G may then be expressed as a function of the ratio of the cross section of the cone to the area of light transducer **106** which reduces to Equation 4:

$$G = \frac{f^2}{(f-d)^2} \quad (4)$$

Curve **600** shows optical gain G as a function of distance d for a T-1 $\frac{3}{4}$ enclosure having a spherical lens **578** with radius R of 5.0 mm and a focal length f of 15.0 mm. As light transducer **106** moves farther from lens **578**, the optical gain increases.

The distance d between lens **578** and light transducer **106** can be adjusted for optimal performance of ambient light sensor **48** and glare sensor **52**. Ambient light sensor **48** should have a wide field of view but need not be as sensitive as glare sensor **52**. Glare sensor **52** should have a narrower field of view but must be more sensitive and, therefore, benefits from a higher optical gain. For the lens described with regards to FIGS. **29** and **30** above, a distance d of between 2 mm and 3 mm is suitable for ambient light sensor **48** and a distance d of between 6 mm and 7 mm is suitable for glare sensor **52**. In addition to modifying lens parameters, other lens types such as aspheric, cylindrical, and the like are possible within the spirit and scope of the present invention.

Referring now to FIG. **31**, a graph illustrating frequency response of the human eye is shown. Curve **610** is the relative photopic or daylight frequency response of the human eye. Curve **612** is the relative scotopic or night frequency response of the human eye. In addition to being more sensitive to light intensity, scotopic response **612** is shifted more towards violet than photopic response **610**. In order to preserve night vision, which degrades rapidly when exposed to bright light particularly in the range of scotopic curve **612**, exposed light transducer **106** should have a

frequency response similar to scotopic curve **612**. If this is not practical, exposed light transducer **106** should at least have an attenuated infrared response. This is increasingly more important as high intensity discharge (HID) headlamps, which emit more bluish light than do incandescent or halogen lamps, gain in popularity.

Referring now to FIG. **32**, a graph illustrating frequency response of a typical light transducer is shown. The relative frequency response of a typical photodiode is shown as curve **620**. When compared to scotopic response curve **612**, the frequency response of exposed light transducer **106** contains significantly more infrared sensitivity. As described with regards to FIG. **2** above, filter **58,60** may be placed before or incorporated into sensor **48,52** so that the output of exposed light transducer **106** more closely resembles scotopic frequency response **612** of the human eye.

Referring now to FIG. **33**, a drawing of an enclosure incorporating an infrared filter according to an embodiment of the present invention is shown. Window **102** in enclosure **100** includes infrared filter **630** operative to attenuate infrared components of light rays **570** striking exposed light transducer **106**. Infrared filter **630** may be a hot mirror available from Optical Coating Laboratories, Inc. of Santa Rosa, Calif. A lens, such as described with regards to FIGS. **28-30** above, may be placed in front of infrared filter **630**. Additional filtering for exposed light transducer **106** is described in U.S. Pat. No. 4,799,768 titled "Automatic Rearview Mirror with Filtered Light Sensors" to Gahan, which is incorporated herein by reference.

While embodiments of the invention have been illustrated and described, it is not intended that these embodiments illustrate and describe all possible forms of the invention. Rather, it is intended that the following claims cover all modifications and alternative designs, and all equivalents, that fall within the spirit and scope of this invention.

What is claimed is:

1. A light sensor comprising:

- a photodiode light transducer exposed to light, the exposed light transducer operative to accumulate charge in proportion to light incident over an integration period; and
- a sensor logic in communication with the exposed light transducer, the sensor logic operative to
 - (a) determine a light integration period prior to the beginning of integration,
 - (b) reset the charge accumulated in the exposed light transducer at the beginning of the determined light integration period,
 - (c) measure the charge accumulated by the exposed light transducer over the determined light integration period, and
 - (d) determine a pulse having a width based on the measured accumulated exposed light transducer charge.

2. A light sensor as in claim **1** further comprising a comparator with one input connected to the exposed light transducer and the other input connected to a switched capacitor circuit, the switched capacitor circuit operable to charge a capacitor to a fixed voltage when the switch is closed and to discharge the capacitor at a constant rate when the switch is open, wherein the sensor logic is further operative to close the switch during the determined light integration period and open the switch after the determined light integration period, thereby creating the pulse at the comparator output.

3. A light sensor as in claim **2** further comprising a second comparator with one input connected to a fixed voltage and

the other input connected to the switched capacitor circuit, the second comparator output operative to inhibit output of the determined pulse if the ramp voltage is less than the fixed voltage.

4. A light sensor as in claim 1 further comprising a photodiode light transducer shielded from light, the shielded light transducer operative to accumulate charge in proportion to noise over the integration period, wherein the sensor logic is further operative to:

reset the charge accumulated in the shielded light transducer at the beginning of the determined light integration period;

measure the charge accumulated by the shielded light transducer over the determined light integration period; and

determine an output pulse having a width based on the difference between the measured accumulated exposed light transducer charge and the measured accumulated shielded light transducer charge.

5. A light sensor as in claim 4 wherein the light sensor has an input for receiving an integration signal and wherein the noise is dependent on the light sensor temperature, the sensor logic further operable to:

determine an integration period based on the integration signal; and

output the output pulse after a time length following the end of the integration signal, the time length based on the noise level, the time length thereby indicating the light sensor temperature.

6. A light sensor as in claim 1 wherein the light integration period is determined from the asserted portion of a control signal received by the sensor logic.

7. A light sensor as in claim 1 wherein the sensor control is operative to determine each light integration period by cycling through a sequence of predetermined time periods.

8. A light sensor as in claim 1 further comprising at least one additional exposed photodiode light transducer, each additional exposed light transducer operative to accumulate charge in proportion to light incident over an integration period at a rate different than the rate of any other exposed light transducer, the sensor logic further operative to:

reset the charge accumulated in each of the at least one additional exposed light transducer at the beginning of the determined light integration period;

measure the charge accumulated by each of the at least one additional exposed light transducer over the determined light integration period; and

output a pulse having a width based on the measured accumulated charge for each of the at least one additional exposed light transducer.

9. A light sensor as in claim 8 wherein each exposed light transducer has a different collector area thereby having a different charge accumulation rate.

10. A light sensor as in claim 8 wherein each exposed light transducer has an aperture for admitting light incident on the sensor, each sensor aperture having a different admitting area thereby giving each exposed light transducer a different charge accumulation rate.

11. A light sensor as in claim 1 wherein the light transducer comprises:

a photodiode overlaying a substrate, the photodiode operative to accumulate incident charge in a photodiode well formed in a region of the substrate underlying the photodiode, the photodiode having an intrinsic photodiode capacitance;

a floating diffusion formed in the substrate, the floating diffusion having a diffusion well formed in a region of

the substrate underlying the floating diffusion when the charge is reset, the floating diffusion operative to eliminate charge in the diffusion well when the charge is reset, the floating diffusion charge determining an output potential, the floating diffusion having an intrinsic floating diffusion capacitance; and

a transmission gate between the photodiode and the floating diffusion, the transmission gate defining a transmission well formed in a region of the substrate between the region of the substrate underlying the photodiode and the region of the substrate underlying the floating diffusion, the transmission well having a depth shallower than the photodiode well and the diffusion well, the transmission gate having an intrinsic transmission gate capacitance;

wherein, when the charge is reset, charge in the photodiode well above the depth of the transmission well flows through the transmission well, through the floating diffusion, and is eliminated; and

wherein, during the determined light integration period, charge produced by light incident on the photodiode flows through the transmission well and into the diffusion well, producing output voltage inversely proportional to the floating diffusion capacitance, until the diffusion well is filled to the depth of the transmission well wherein charge produced by light incident on the photodiode fills the photodiode well, the transmission well, and the diffusion well, producing output voltage inversely proportional to the sum of the floating diffusion capacitance, the photodiode capacitance, and the transmission gate capacitance;

thereby providing a first sensitivity during charge accumulation in the diffusion well only and a second sensitivity during charge accumulation in the diffusion well, the transmission well, and the photodiode well, the first sensitivity greater than the second sensitivity.

12. A light sensor as in claim 11 further comprising an anti-bloom gate between the photodiode and a source voltage diffusion, the anti-bloom gate defining an anti-blooming well formed in a region of the substrate between the region of the substrate underlying the photodiode and the source voltage diffusion, the anti-blooming well having a depth shallower than the transmission well.

13. A light sensor package comprising:

an enclosure having a window for receiving light, the enclosure admitting a power pin, a ground pin, and an output pin;

an exposed photodiode light transducer disposed within the enclosure, the exposed light transducer operative to accumulate charge in proportion to light received through the window incident on the exposed light transducer over an integration period;

a light-to-voltage circuit disposed within the enclosure and in communication with the exposed light transducer, the light-to-voltage circuit operative to output a light voltage signal based on charge accumulated by the exposed light transducer; and

a voltage-to-pulse circuit disposed within the enclosure and in communication with the light-to-voltage circuit, the voltage-to-pulse circuit operative to output a pulse on the output pin, the pulse width based on the light voltage signal.

14. A light sensor package as in claim 13 further comprising:

a photodiode light transducer shielded from light, the shielded light transducer having the same construction

as the exposed light transducer, the shielded light transducer operative to accumulate charge in proportion to noise over the integration period; and

a noise-to-voltage circuit disposed within the enclosure and in communication with the shielded light transducer, the noise-to-voltage circuit operative to output a noise voltage signal based on charge accumulated by the shielded light transducer;

wherein the voltage-to-pulse circuit is operative to output a pulse on the output pin having a pulse width based on the difference between the light voltage signal and the noise voltage signal.

15. A light sensor package as in claim 13 further comprising a sensor logic disposed within the enclosure and in communication with exposed light transducer and the light-to-voltage circuit, the sensor logic operative to:

- determine a light integration period;
- reset the charge accumulated in the exposed light transducer at the beginning of the determined light integration period; and
- control the accumulation of charge by the exposed light transducer during the determined light integration period.

16. A light sensor package as in claim 15 wherein the sensor logic is operative to determine the light integration period from the asserted portion of a control signal received on the output pin.

17. A light sensor package as in claim 15 wherein the sensor logic is operative to determine each light integration period by cycling through a sequence of predetermined time periods.

18. A light sensor package as in claim 15 further comprising at least one additional exposed photodiode light transducer, each additional exposed light transducer operative to accumulate charge in proportion to light incident over an integration period at a rate different than the rate of any other exposed light transducer, the sensor logic further operative to:

- reset the charge accumulated in the at least one additional exposed light transducer at the beginning of the determined light integration period;
- measure the charge accumulated by the at least one additional exposed light transducer over the determined light integration period; and
- output a pulse having a width based on the measured accumulated charge for each of the at least one additional exposed light transducer.

19. A light sensor package as in claim 18 wherein each exposed light transducer has a different collector area thereby having a different charge accumulation rate.

20. A light sensor package as in claim 18 wherein each exposed light transducer has an aperture for admitting light incident on the sensor, each sensor aperture having a different admitting area thereby giving each exposed light transducer a different charge accumulation rate.

21. A light sensor comprising:

- a photodiode overlaying a substrate, the photodiode operative to accumulate charge generated by light incident on the photodiode in a photodiode well formed in a region of the substrate underlying the photodiode, the photodiode having an intrinsic photodiode capacitance;
- a floating diffusion formed in the substrate, the floating diffusion having a diffusion well formed in a region of the substrate underlying the floating diffusion when the charge is reset, the floating diffusion operative to eliminate charge in the diffusion well when the charge is reset, the floating diffusion charge determining an output potential, the floating diffusion having an intrinsic floating diffusion capacitance; and
- a transmission gate between the photodiode and the floating diffusion, a transmission well formed in a region of the substrate between the region of the substrate underlying the photodiode and the region of the substrate underlying the floating diffusion, the transmission well having a depth shallower than the photodiode well and the diffusion well, the transmission gate having an intrinsic transmission gate capacitance;

wherein, when the charge is reset, charge in the photodiode well above the depth of the transmission well flows through the transmission well, through the floating diffusion, and is eliminated; and

wherein, during a light integration period, charge produced by light incident on the photodiode flows through the transmission well and into the diffusion well, producing output voltage inversely proportional to the floating diffusion capacitance, until the diffusion well is filled to the depth of the transmission well wherein charge produced by light incident on the photodiode fills the photodiode well, the transmission well, and the diffusion well, producing output voltage inversely proportional to the sum of the floating diffusion capacitance, the photodiode capacitance, and the transmission gate capacitance;

thereby providing a first sensitivity during charge accumulation in the diffusion well only and a second sensitivity during charge accumulation in the diffusion well, the transmission well, and the photodiode well, the first sensitivity greater than the second sensitivity.

22. A light sensor as in claim 21 further comprising an anti-bloom gate between the photodiode and a source voltage diffusion, the anti-bloom gate defining an anti-blooming well formed in a region of the substrate between the region of the substrate underlying the photodiode and the source voltage diffusion, the anti-blooming well having a depth shallower than the transmission well.

* * * * *